

UG87

Industrial LoRaWAN Gateway User Guide

Xiamen Ursalink Technology Co., Ltd.



Preface

Thanks for choosing Ursalink UG87 industrial LoRaWAN gateway. The UG87 industrial LoRaWAN gateway delivers tenacious connection over network with full-featured design such as automated failover/failback, extended operating temperature, dual SIM cards, hardware watchdog, VPN, Gigabit Ethernet and beyond.

This guide shows you how to configure and operate the UG87 industrial LoRaWAN gateway. You can refer to it for detailed functionality and gateway configuration.

Readers

This guide is mainly intended for the following users:

- Network Planners
- On-site technical support and maintenance personnel
- Network administrators responsible for network configuration and maintenance

© 2017 Xiamen Ursalink Technology Co., Ltd.

All rights reserved.

All information in this user guide is protected by copyright law. Whereby, no organization or individual shall copy or reproduce the whole or part of this user guide by any means without written authorization from Xiamen Ursalink Technology Co., Ltd.

Products Covered

This guide explains how to configure the following devices:

- Ursalink UG87 LoRaWAN gateway

Related Documents

Document	Description
Ursalink UG87 Datasheet	Datasheet for the Ursalink UG87 industrial LoRaWAN gateway.
Ursalink UG87 Quick Start Guide	Quick Installation Guide for the Ursalink UG87 industrial LoRaWAN gateway.

Declaration of Conformity

UG87 is in conformity with the essential requirements and other relevant provisions of the CE, FCC, and RoHS.

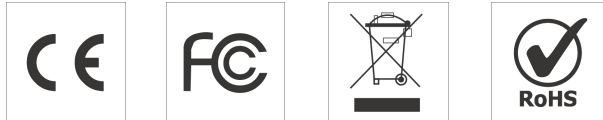

For assistance, please contact
 Ursalink technical support:
 Email: support@ursalink.com
 Tel.: 86-592-5023060
 Fax: 86-592-5023065

Revision History

Date	Doc Version	Description
July 13, 2019	V1.1	Initial version
Aug. 6, 2019	V1.2	Add New Function: 1. Python Development 2. Send data to LoRaWAN nodes

Contents

Chapter 1 Product Introduction	7
1.1 Overview	7
1.2 Advantages	7
1.3 Specifications	8
1.4 Dimensions (mm)	10
Chapter 2 Access to Web GUI	11
2.1 PC Configuration for Web GUI Access to gateway	11
2.2 Access to Web GUI of gateway	12
Chapter 3 Web Configuration	14
3.1 Status	14
3.1.1 Overview	14
3.1.2 LoRa	14
3.1.3 Cellular	17
3.1.4 Network	19
3.1.5 WLAN (Only Applicable to Wi-Fi Version)	20
3.1.6 VPN	21
3.1.7 Host List	22
3.2 LoRaWAN	23
3.2.1 Packet Forwarder	23
3.2.1.1 General	23
3.2.1.2 Radios	24
3.2.1.3 Advanced	26
3.2.1.4 Custom	27
3.2.1.5 Traffic	27
3.2.2 Network Server	28
3.2.2.1 General	28
3.2.2.2 Application	30
3.2.2.3 Profiles	31
3.2.2.4 Device	32
3.2.2.5 Packets	32
3.3 Network	35
3.3.1 Interface	35
3.3.1.1 Port	35
3.3.1.2 WAN	36
3.3.1.3 LAN	39
3.3.1.4 VLAN Trunk	40
3.3.1.5 WLAN (Only Applicable to Wi-Fi Version)	41
3.3.1.6 Cellular	42
3.3.1.7 Loopback	46
3.3.2 Firewall	47
3.3.2.1 Security	47

3.3.2.2 ACL.....	47
3.3.2.3 DMZ.....	49
3.3.2.4 Port Mapping.....	49
3.3.2.5 MAC Binding.....	50
3.3.3 QoS.....	51
3.3.4 DHCP.....	52
3.3.4.1 DHCP Server.....	52
3.3.4.2 DHCP Relay.....	53
3.3.5 DDNS.....	54
3.3.6 Link Failover.....	54
3.3.6.1 SLA.....	54
3.3.6.2 Track.....	55
3.3.6.3 VRRP.....	56
3.3.6.4 WAN Failover.....	58
3.3.7 VPN.....	59
3.3.7.1 DMVPN.....	59
3.3.7.2 IPsec.....	60
3.3.7.3 GRE.....	63
3.3.7.4 L2TP.....	64
3.3.7.5 PPTP.....	66
3.3.7.6 OpenVPN Client.....	68
3.3.7.7 OpenVPN Server.....	69
3.3.7.8 Certifications.....	71
3.4 System.....	73
3.4.1 General Settings.....	73
3.4.1.1 General.....	73
3.4.1.2 System Time.....	74
3.4.1.3 SMTP.....	76
3.4.1.4 Phone.....	76
3.4.1.5 Email.....	77
3.4.2 User Management.....	78
3.4.2.1 Account.....	78
3.4.2.2 User Management.....	79
3.4.3 SNMP.....	80
3.4.3.1 SNMP.....	80
3.4.3.2 MIB View.....	81
3.4.3.3 VACM.....	81
3.4.3.4 Trap.....	82
3.4.3.5 MIB.....	83
3.4.4 AAA.....	83
3.4.4.1 RADIUS.....	83
3.4.4.2 TACACS+.....	84
3.4.4.3 LDAP.....	84
3.4.4.4 Authentication.....	85

3.4.5 Device Management.....	86
3.4.6 Events.....	87
3.4.6.1 Events.....	87
3.4.6.2 Events Settings.....	88
3.5 Maintenance.....	89
3.5.1 Tools.....	89
3.5.1.1 Ping.....	89
3.5.1.2 Traceroute.....	89
3.5.2 Schedule.....	90
3.5.3 Log.....	90
3.5.3.1 System Log.....	91
3.5.3.2 Log Settings.....	91
3.5.4 Upgrade.....	92
3.5.5 Backup and Restore.....	93
3.5.6 Reboot.....	94
3.6 APP.....	95
3.6.1 Python.....	95
3.6.1.1 Python.....	96
3.6.1.2 App Manager Configuration.....	96
3.6.1.3 Python App.....	97
Chapter 4 Application Examples.....	98
4.1 Application Configuration.....	98
4.2 Device Profiles Configuration.....	102
4.3 Device Configuration.....	104
4.4 Send Data to Device.....	107
4.5 Restore Factory Defaults.....	111
4.5.1 Via Web Interface.....	111
4.5.2 Via Hardware.....	113
4.6 Firmware Upgrade.....	113
4.7 Cellular Connection.....	114
4.8 Dual SIM Backup Application Example.....	116
4.9 Wi-Fi Application Example.....	119
4.9.1 AP Mode.....	119
4.9.2 Client Mode.....	120

Chapter 1 Product Introduction

1.1 Overview

Ursalink UG87 is an industrial LoRaWAN gateway with embedded intelligent software features designed for multifarious M2M/IoT applications. Options like cellular network or Wi-Fi provide drop-in connectivity for operators and make a giant leap in maximizing uptime. Adopting high-performance industrial platform of 64-bit CPU and wireless module, the UG87 enables you to scale up M2M application combining data within limited time and budget. The UG87 is particularly ideal for smart city, smart agriculture, building automation, digital factory, environment protection, water conservancy and so on.

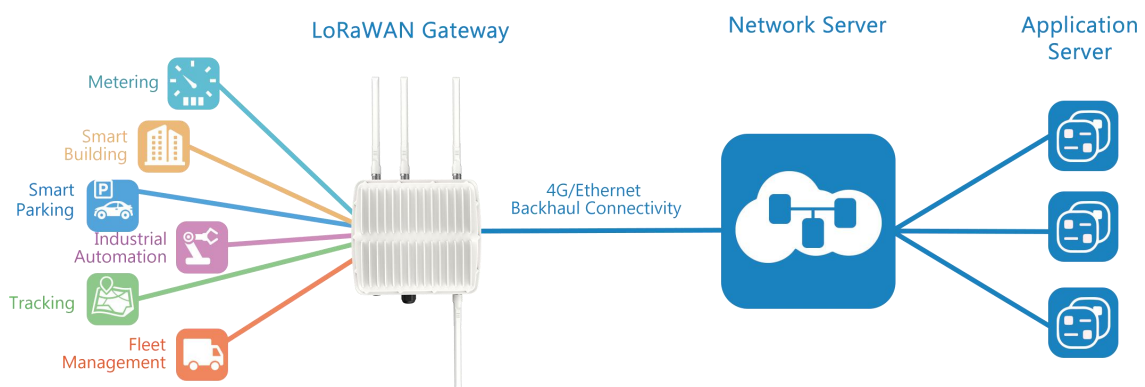

Figure 1-1

1.2 Advantages

Benefits

- Built-in industrial CPU and big memory;
- Ethernet, 2.4GHz/5GHz Wi-Fi and global 2G/3G/LTE options make it easy to get connected
- Embedded network server and compliant with several third party network servers
- MQTT, HTTP or HTTPS protocol for data transmission to application server
- Embedded GPS module for high-precision time synchronization
- Rugged enclosure, optimized for wall or pole mounting
- 3-year warranty included

Security & Reliability

- Automated failover/failback between Ethernet and Cellular (dual SIM)
- Enable unit with security frameworks like IPsec/OpenVPN/GRE/L2TP/PPTP/ DMVPN
- Embedded hardware watchdog to automatically recover from various failure and ensure highest level of availability

- Establish a secured mechanism on centralized authentication and features authorization of device access by supporting AAA (TACACS+, RADIUS, LDAP, local authentication) and multiple levels of user authority

Easy Maintenance

- Uralink DeviceHub provides easy setup, mass configuration, and centralized management of remote devices
- The user-friendly web interface design and various upgrading options help administrator to manage the device as easy as pie
- WEB GUI and CLI enable the admin to achieve quick configuration and simple management among a large quantity of devices
- Users can efficiently manage the remote devices on the existing platform through the industrial standard SNMP

Capabilities

- Link remote devices in an environment where communication technologies are constantly changing
- Industrial 64-bit ARM Cortex-A53 processor, high-performance operating up to 800MHz with low power consumption, and 512 MB memory available to support more applications
- Support wide operating temperature ranging from -40°C to 70°C/-40°F to 158°F

1.3 Specifications

Hardware System	
CPU	800MHz, 64-bit ARM Cortex-A53
Memory	8 GB Flash, 512 MB DDR3 RAM
Storage	1 × M.2 slot supports SATA M.2 SSD
LoRaWAN	
Connectors	1 × 50 Ω N-Type (Center pin: Female)
Channel	8 or 16
Frequency Band	Supports EU 863-870, US 902-928, EU 433, AU 915-928, CN 470-510 IN865 and KR 920-923 Band
Sensitivity	-140dBm Sensitivity @292bps
Output Power	27dBm Max
Protocol	V1.0 Class A/Class C and V1.0.2 Class A/Class C

Ethernet	
Ports	1 × RJ-45 (PoE PD Default)
Physical Layer	10/100/1000 Base-T (IEEE 802.3)
Data Rate	10/100/1000 Mbps (auto-sensing)
Interface	Auto MDI/MDIX
Mode	Full or half duplex (auto-sensing)
Cellular Interfaces (Optional)	
Connectors	1 × 50 Ω N-Type (Center pin: Female)
SIM Slots	2
Wi-Fi Interfaces (Optional)	
Connectors	1 × 50 Ω N-Type (Center PIN: Female)
Standards	IEEE 802.11 b/g/n/ac
Tx Power	802.11b: 16 dBm +/-1.5 dBm (11 Mbps) 802.11g: 15 dBm +/-1.5 dBm (54 Mbps) 802.11n@2.4 GHz: 14 dBm +/-1.5 dBm (MCS7) 802.11n@5 GHz: 11 dBm +/-2 dBm (MCS7) 802.11ac@5 GHz: 10 dBm +/-2 dBm (MCS9)
GPS	
Connectors	1 × 50 Ω N-Type (Center PIN: Female)
Software	
Network Protocols	PPP, PPPOE, SNMP v1/v2c/v3, TCP, UDP, DHCP,DDNS, VRRP, HTTP, HTTPS, DNS, Sntp, Telnet, VLAN, SSH, MQTT, etc.
VPN Tunnel	DMVPN/IPsec/OpenVPN/PPTP/L2TP/GRE
Access Authentication	CHAP/PAP/MS-CHAP/MS-CHAPV2
Firewall	ACL/DMZ/Port Mapping/MAC Binding
Management	Web, CLI, SMS, On-demand dial up
Reliability	VRRP, Dual SIM Backup
Power Supply and Consumption	
Connector	Default: 1 × 802.3af/at PoE input Optional: 9-48VDC/220VAC Circular Connector
Consumption	Max 8.2W
Physical Characteristics	
Ingress Protection	IP67
Dimensions	256 x 226 x 90.5 mm

Mounting	Wall or Pole Mounting
Others	
Reset Button	1 × RST
LED Indicators	1 × PWR, 1 × SYS, 1 × L1 , 1 × L2
Built-in	Watchdog, RTC, Timer
Certifications	RoHS, CE, FCC
Environmental	
Operating Temperature	-40°C to +70°C (-40°F to +158°F) Reduced cellular performance above 60°C
Storage Temperature	-40°C to +85°C (-40°F to +185°F)
Ethernet Isolation	1.5 kV RMS
Relative Humidity	0% to 95% (non-condensing) at 25°C/77°F

1.4 Dimensions (mm)

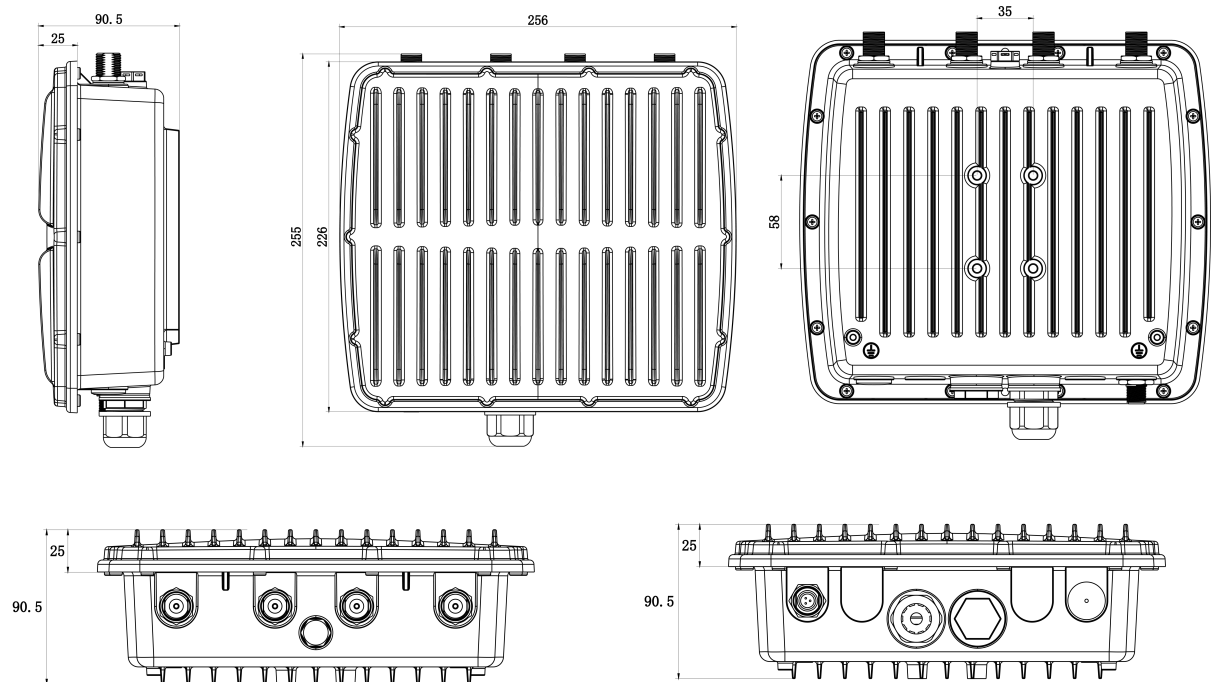

Chapter 2 Access to Web GUI

This chapter explains how to access to Web GUI of the UG87.

2.1 PC Configuration for Web GUI Access to gateway

Please connect PC to GE port of UG87 directly. PC can obtain an IP address, or you can configure a static IP address manually. The following steps are based on Windows 10 operating system for your reference.

The following steps are based on Windows 10 operating system for your reference.

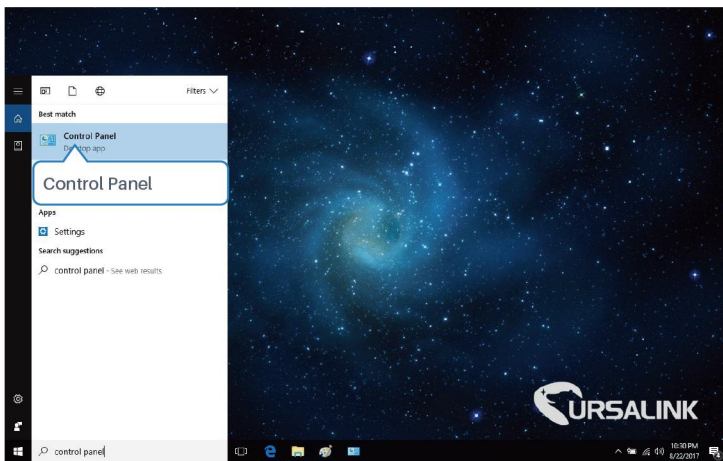

① Click "Search Box" to search "Control Panel" on the Windows 10 taskbar.

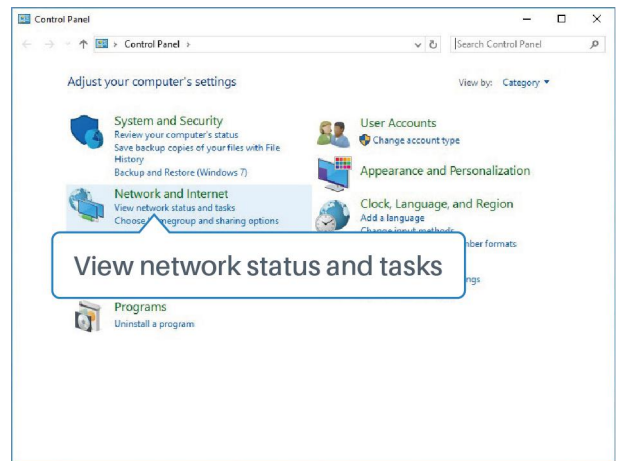

② Click "Control Panel" to open it, and then click "View network status and tasks".

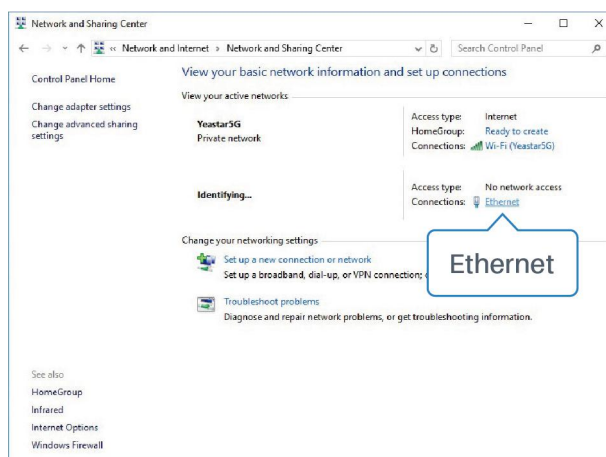

③ Click "Ethernet" (May have different name).

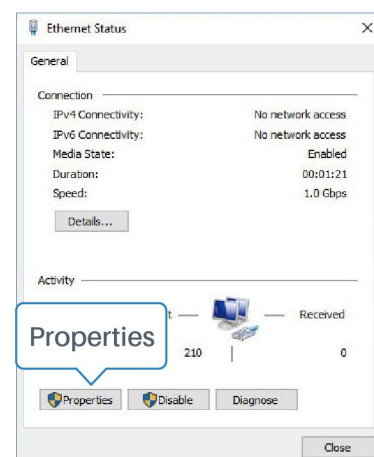

④ Click "Properties".

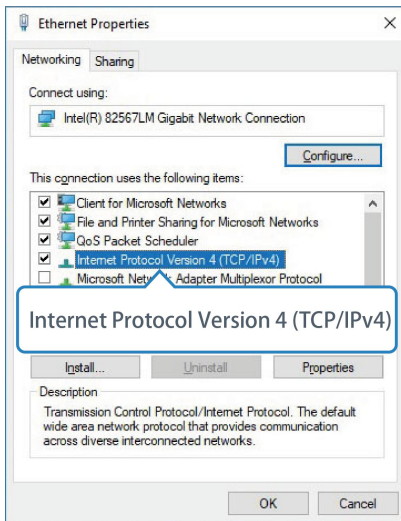

⑤ Double Click "Internet Protocol Version 4 (TCP/IPv4)" to configure IP address and DNS server.

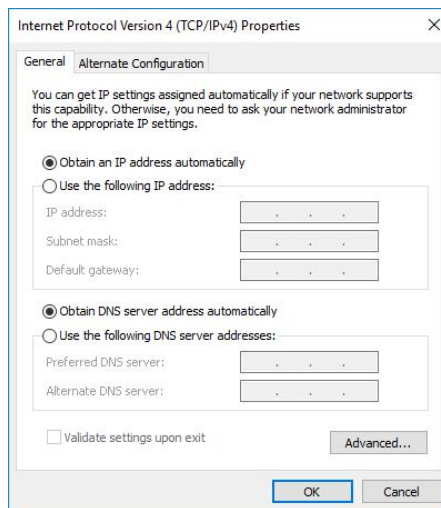

⑥ Method 1: click "Obtain an IP address automatically";

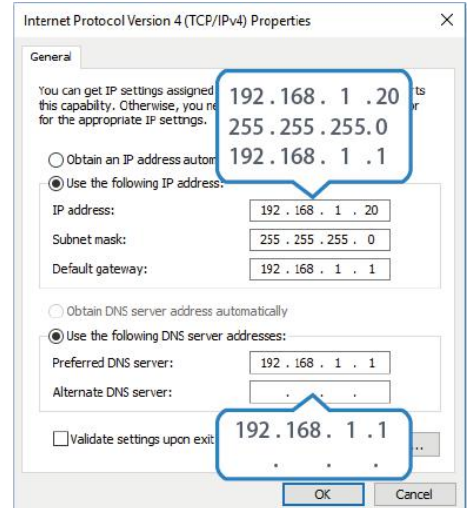

Method 2: click "Use the following IP address" to assign a static IP manually within the same subnet of the gateway.

(Note: remember to click "OK" to finish configuration.)

2.2 Access to Web GUI of gateway

Ursalink gateway provides Web-based configuration interface for management. If this is the first time you configure the gateway, please use the default settings below.

Username: admin

Password: password

IP Address: 192.168.1.1

DHCP Server: Enabled

1. Start a Web browser on your PC (Chrome and IE are recommended), type in the IP address, and press Enter on your keyboard.
2. Enter the username, password, and click "Login".

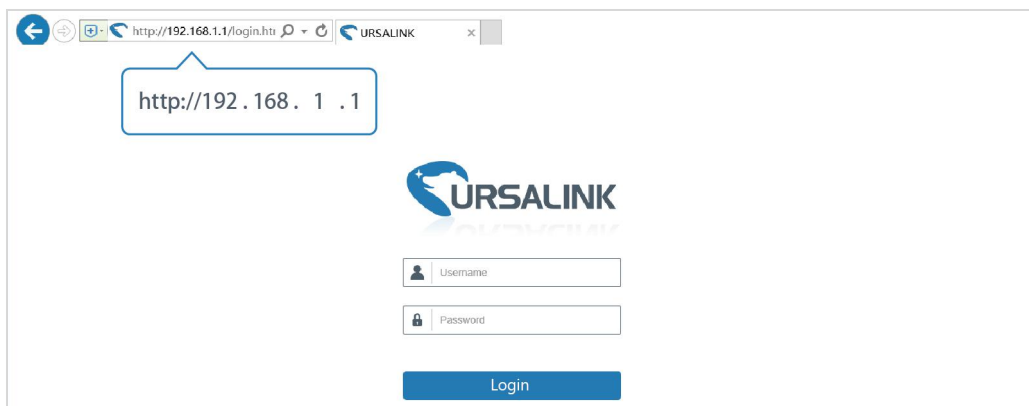

If the SIM card is connected to cellular network with public IP address, you can access WEB GUI remotely via the public IP address when remote access is enabled.

! If you enter the username or password incorrectly more than 5 times, the login page will be locked for 10 minutes.

- When you login with the default username and password, you will be asked to modify the password. It's suggested that you change the password for the sake of security. Click "Cancel" button if you want to modify it later.

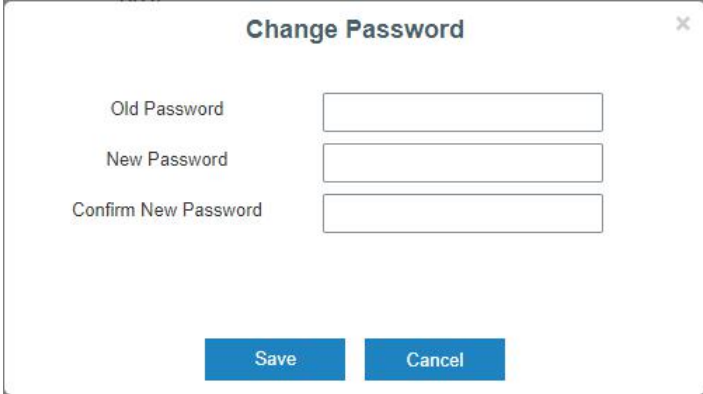

A dialog box titled "Change Password" with a close button (X) in the top right corner. It contains three input fields: "Old Password", "New Password", and "Confirm New Password". At the bottom, there are two buttons: "Save" and "Cancel".

- After you login the Web GUI, you can view system information and perform configuration on the gateway.



For your device security, please change the default password

Status	Overview	LoRa	Cellular	Network	VPN	Host List
LoRaWAN	System Information					
Network	Model	UG87				
System	Partnumber	L00E-G-P-EU868				
Maintenance	Serial Number	621692497387				
APP	Firmware Version	80.0.0.18				
	Hardware Version	V2.0				
	Local Time	2019-07-18 14:36:34				
	Uptime	00:20:35				
	CPU Load	17%				
	RAM (Capacity/Available)	512MB/249MB(48.63%)				
	Flash (Capacity/Available)	64MB/0MB(0%)				
	eMMC (Capacity/Available)	3.0G/2.6G(87.37%)				
				Manual Refresh	Refresh	

Chapter 3 Web Configuration

3.1 Status

3.1.1 Overview

You can view the system information of the gateway on this page.

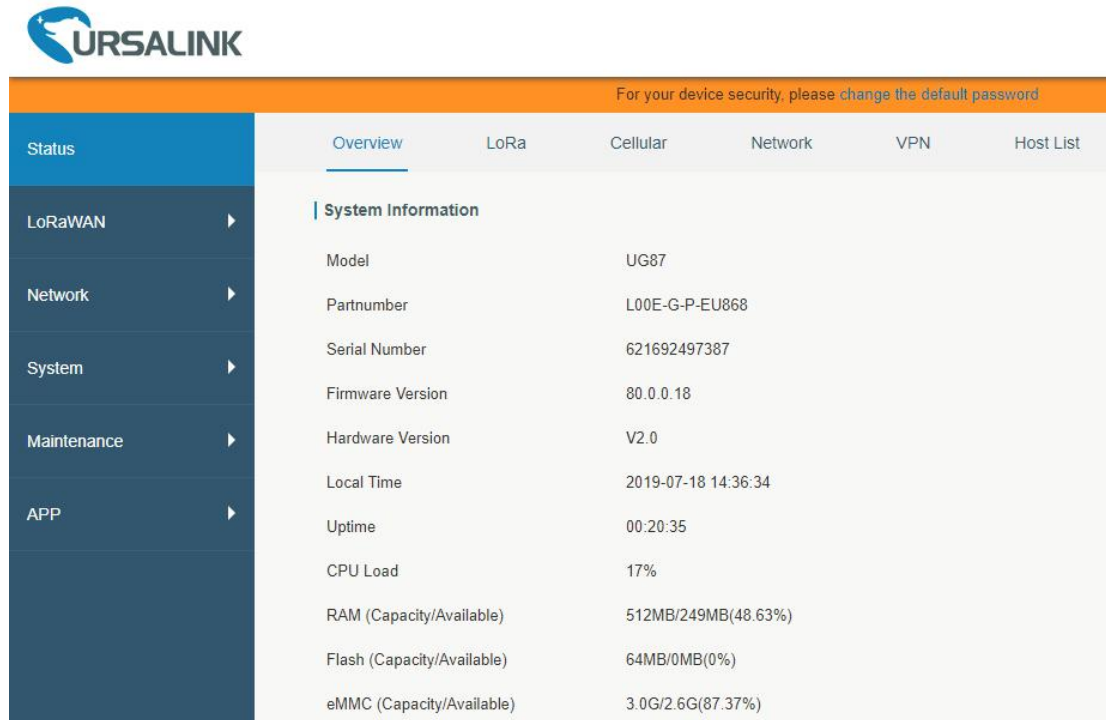

The screenshot shows the URSALINK web configuration interface. At the top, there is a blue navigation bar with the URSALINK logo and a warning message: "For your device security, please change the default password". Below the navigation bar, there is a sidebar menu with options: Status, LoRaWAN, Network, System, Maintenance, and APP. The main content area is titled "System Information" and displays the following details:

Item	Description
Model	UG87
Partnumber	L00E-G-P-EU868
Serial Number	621692497387
Firmware Version	80.0.0.18
Hardware Version	V2.0
Local Time	2019-07-18 14:36:34
Uptime	00:20:35
CPU Load	17%
RAM (Capacity/Available)	512MB/249MB(48.63%)
Flash (Capacity/Available)	64MB/0MB(0%)
eMMC (Capacity/Available)	3.0G/2.6G(87.37%)

Figure 3-1-1-1

System Information	
Item	Description
Model	Show the model name of gateway.
Serial Number	Show the serial number of gateway.
Firmware Version	Show the currently firmware version of gateway.
Hardware Version	Show the currently hardware version of gateway.
Local Time	Show the currently local time of system.
Uptime	Show the information on how long the gateway has been running.
CPU Load	Show the current CPU utilization of the gateway.
RAM (Capacity/Available)	Show the RAM capacity and the available RAM memory.
Flash (Capacity/Available)	Show the Flash capacity and the available Flash memory.
eMMC (Capacity/Available)	Show the eMMC capacity and the available eMMC memory.

Table 3-1-1-1 System Information

3.1.2 LoRa

You can view the LoRaWAN status of gateway on this page.

Basic	
Mode	Packet Forwarder
Version	4.0.1
Status	Running
Gateway ID	24E124FFFEF0132D
Region Code	AS923
Server Address	localhost
Uplink	
Packet Received	1
Packets Received State	CRC_OK: 0.00%, CRC_FAIL: 100.00%, NO_CRC: 0.00%
Packet Forwarded	1 (208 bytes)
Push Data Datagrams Sent	1 (456 bytes)
Push Data Acknowledged	0.00%
Downlink	
Pull Data Sent	3 (0.00% acknowledged)
Pull Resp Datagrams Received	0 (0 bytes)
Packets Sent to node	0 (0 bytes)
Packets Sent Errors	0

Figure 3-1-2-1

LoRaWAN Status (Packet Forwarder Mode)	
Item	Description
Mode	Show the working mode of LoRaWAN.
Version	Show the version of packet forwarder software.
Status	Show the status of packet forwarder. Value include Running, Disabled.
Gateway ID	Show the ID of the gateway.
Region Code	Show the LoRa region code which is based on the gateway's variant..
Server Address	Show the IP address of remote LoRaWAN network server.
Packet Received	Show the count of data packet from node to gateway.
Packets received State	Show the RF packets receiving state: CRC_OK: Percentage of CRC verification CRC_Fail: Percentage of CRC verification failure NO_CRC: Percentage of abnormal packets without CRC
Packets forwarded	Packets that CRC verified are sent from gateway to server.
Push Data Datagrams Sent	The total quantity of packets sent from gateway to server, including the RF packets forwarded and statistics packets.
Push Data Acknowledged	Percentage of acknowledged packets among Push Data Datagrams Sent.
Pull Data Sent	Show the number of keepalive packets sent to the server, and

	percentage of acknowledged packet regarding the keepalive packet from the server.
Pull Resp Datagrams Received	Show the packet counts and size that will be sent from server to gateway.
RF Packets Sent to node	Show the RF packet counts and size that will be sent from gateway to node.
RF Packets Sent Errors	Show the RF packet counts that fail to be sent from server to node.

Table 3-1-2-1 LoRaWAN Status (Packet Forwarder Mode)

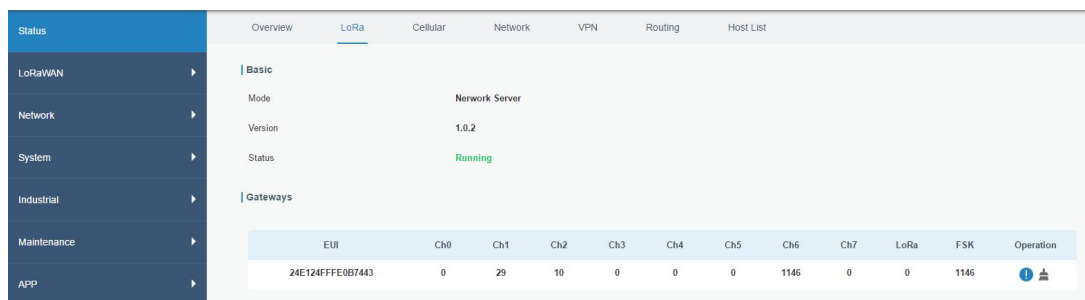



Figure 3-1-2-2

LoRaWAN Status (Network Server)	
Item	Description
Mode	Show the working mode of LoRaWAN.
Version	Show the version of installed lora network server file.
Status	Show the status of network server. Value include Running, Disabled.
EUI	Show the identifier of the gateway.
Ch0	Show the number of packets received on Ch0.
Ch1	Show the number of packets received on Ch1.
Ch2	Show the number of packets received on Ch2.
Ch3	Show the number of packets received on Ch3.
Ch4	Show the number of packets received on Ch4.
Ch5	Show the number of packets received on Ch5.
Ch6	Show the number of packets received on Ch6.
Ch7	Show the number of packets received on Ch7.
LoRa	Show the number of packets received on LoRa.
FSK	Show the number of packets received on FSK.

Table 3-1-2-2 LoRa WAN-Status-Network Server

Click  to clean every channel's data, then the packet receive counter will be restarted.

Click  to view the details of the connected gateway, as the following picture shows.

Gateway Details											
Gateway EUI	24E124FFFE0B7443										
IP Address	localhost										
Version	4.0.1										
Uplink	1170										
Downlink	15										
Ch0	Ch1	Ch2	Ch3	Ch4	Ch5	Ch6	Ch7	LoRa	FSK	CRC	Total
923.0	923.2	923.4	922.0	922.2	922.4	922.6	922.8	922.1	922.6		
0	29	10	0	0	0	1146	0	0	1146	3	1188

Figure 4-1-4-6

LoRaWAN-Network Server-Status-Gateway Detail	
Item	Description
Gateway EUI	Show the identifier of the gateway.
IP Address	Show the IP address of the gateway.
Version	Show the version of packet forwarder software.
Uplink	Show the number of uplink packets which the gateway received.
Downlink	Show the number of downlink packets which the gateway received.
Ch0	Show the frequency of Ch0 and number of packets received on Ch0.
Ch1	Show the frequency of Ch1 and number of packets received on Ch1.
Ch2	Show the frequency of Ch2 and number of packets received on Ch2.
Ch3	Show the frequency of Ch3 and number of packets received on Ch3.
Ch4	Show the frequency of Ch4 and number of packets received on Ch4.
Ch5	Show the frequency of Ch5 and number of packets received on Ch5.
Ch6	Show the frequency of Ch6 and number of packets received on Ch6.
Ch7	Show the frequency of Ch7 and number of packets received on Ch7.
LoRa	Show the frequency of LoRa channel and number of packets received on LoRa channel.
FSK	Show the frequency of FSK channel and number of packets received on FSK channel.
CRC	Show the total number of packets with CRC error.
Total	Show the total number of packets received by the gateway.

Table 4-1-4-6 LoRa WAN-Network Server-Status-Gateway Detail

3.1.3 Cellular

You can view the cellular network status of gateway on this page.

Overview	Cellular	Network	VPN	Routing	Host List
Modem					
Status	Ready				
Model	EC25				
Current SIM	SIM1				
Signal Level	15asu (-83dBm)				
Register Status	Registered (Home network)				
IMSI	460019987103071				
ICCID	89860117838019196629				
ISP	CHN-UNICOM				
Network Type	LTE				
PLMN ID	46001				
LAC	5922				
Cell ID	812c63d				
IMEI	861107031710008				

Figure 3-1-3-1

Modem Information	
Item	Description
Status	Show corresponding detection status of module and SIM card.
Model	Show the model name of cellular module.
Current SIM	Show the current SIM card used.
Signal Level	Show the cellular signal level.
Register Status	Show the registration status of SIM card.
IMSI	Show IMSI of the SIM card.
ICCID	Show ICCID of the SIM card.
ISP	Show the network provider which the SIM card registers on.
Network Type	Show the connected network type, such as LTE, 3G, etc.
PLMN ID	Show the current PLMN ID, including MCC, MNC, LAC and Cell ID.
LAC	Show the location area code of the SIM card.
Cell ID	Show the Cell ID of the SIM card location.
IMEI	Show the IMEI of the module.

Table 3-1-3-1 Modem Information

Network	
Status	Connected
IP Address	10.53.241.18
Netmask	255.255.255.252
Gateway	10.53.241.17
DNS	218.104.128.106
Connection Duration	0 days, 00:04:26

Figure 3-1-3-2

Network Status	
Item	Description
Status	Show the connection status of cellular network.
IP Address	Show the IP address of cellular network.
Netmask	Show the netmask of cellular network.
Gateway	Show the gateway of cellular network.
DNS	Show the DNS of cellular network.
Connection Duration	Show information on how long the cellular network has been connected.

Table 3-1-3-2 Network Status

3.1.4 Network

On this page you can check the LAN status of the gateway.

WAN							
Port	Status	Type	IP Address	Netmask	Gateway	DNS	Duration
GE 0	up	Static	192.168.23.94	255.255.255.0	192.168.23.1	114.114.114.114	12m 14s

Figure 3-1-4-1

LAN Status	
Item	Description
Port	Show the name of WAN port.
Status	Show the status of WAN port. "Up" refers to a status that WAN is enabled and Ethernet cable is connected. "Down" means Ethernet cable is disconnected or WAN function is disabled.
Type	Show the dial-up type of WAN port.
IP Address	Show the IP address of WAN port.
Netmask	Show the netmask of WAN port.
Gateway	Show the gateway of WAN port.
DNS	Show the DNS of WAN port.

Duration	Show the information about how long the Ethernet cable has been connected to WAN port when WAN function is enabled. Once WAN function is disabled or Ethernet cable is disconnected, the duration will stop.
----------	--

Table 3-1-4-1 LAN Status

3.1.5 WLAN (Only Applicable to Wi-Fi Version)

You can check Wi-Fi status on this page, including the information of access point and client.

Overview	LoRa	Cellular	Network	WLAN	VPN	Host List
WLAN Status						
Wireless Status	Enabled					
MAC Address	24:e1:24:f0:27:85					
Interface Type	AP					
SSID	Ursalink_F02786					
Channel	Auto					
Encryption Type	No Encryption					
Status	Up					
IP Address	192.168.100.1					
Netmask	255.255.255.0					
Connection Duration	0 days, 00:08:50					

Figure 3-1-5-1

WLAN Status	
Item	Description
Wireless Status	Show the wireless status.
MAC Address	Show the MAC address.
Interface Type	Show the interface type, such as "AP" or "Client".
SSID	Show the SSID.
Channel	Show the wireless channel.
Encryption Type	Show the encryption type.
Status	Show the connection status.
IP Address	Show the IP address of the gateway.
Netmask	Show the wireless MAC address of the gateway.
Gateway	Show the gateway address in wireless network.
Connection Duration	Show information on how long the Wi-Fi network has been connected.

Table 3-1-5-1 WLAN Status

Associated Stations		
IP Address	MAC Address	Connection Duration

Figure 3-1-5-2

Associated Stations	
Item	Description
IP Address	Show the IP address of access point or client.
MAC Address	Show the MAC address of the access point or client.
Connection Duration	Show information on how long the Wi-Fi network has been connected.

Table 3-1-5-2 WLAN Status

3.1.6 VPN

You can check VPN status on this page, including PPTP, L2TP, IPsec, OpenVPN and DMVPN.

Overview	Cellular	Network	VPN	Routing	Host List
PPTP Tunnel					
Name	Status	Local IP	Remote IP		
pptp_1	Disconnected	-	-		
pptp_2	Disconnected	-	-		
pptp_3	Disconnected	-	-		
L2TP Tunnel					
Name	Status	Local IP	Remote IP		
l2tp_1	Disconnected	-	-		
l2tp_2	Disconnected	-	-		
l2tp_3	Disconnected	-	-		

Figure 3-1-6-1

Overview	Cellular	Network	VPN	Routing	Host List
IPsec Tunnel					
Name	Status	Local IP	Remote IP		
ipsec_1	Disconnected	-	-		
ipsec_2	Disconnected	-	-		
ipsec_3	Disconnected	-	-		
OpenVPN Client					
Name	Status	Local IP	Remote IP		
openvpn_1	Disconnected	-	-		
openvpn_2	Disconnected	-	-		
openvpn_3	Disconnected	-	-		

Figure 3-1-6-2

GRE Tunnel			
Name	Status	Local IP	Remote IP
gre_1	Disconnected	-	-
gre_2	Disconnected	-	-
gre_3	Disconnected	-	-

DMVPN Tunnel			
Name	Status	Local IP	Remote IP
dmpvn	Disconnected	-	-

Figure 3-1-6-3

VPN Status	
Item	Description
Name	Show the name of the VPN tunnel.
Status	Show the status of the VPN tunnel.
Local IP	Show the local tunnel IP of VPN tunnel.
Remote IP	Show the remote tunnel IP of VPN tunnel.

Table 3-1-6-1 VPN Status

3.1.7 Host List

You can view the host information on this page.

Overview	Cellular	Network	VPN	Routing	Host List	GPS
DHCP Leases						
IP		MAC		Lease Remaining Time		
MAC Binding						
IP			MAC			

Figure 3-1-7-1

Host List	
Item	Description
DHCP Leases	
IP Address	Show IP address of DHCP client
MAC Address	Show MAC address of DHCP client
Lease Time Remaining	Show the remaining lease time of DHCP client.
MAC Binding	
IP & MAC	Show the IP address and MAC address set in the Static IP list of DHCP service.

Table 3-1-7-1 Host List Description

3.2 LoRaWAN

3.2.1 Packet Forwarder

3.2.1.1 General

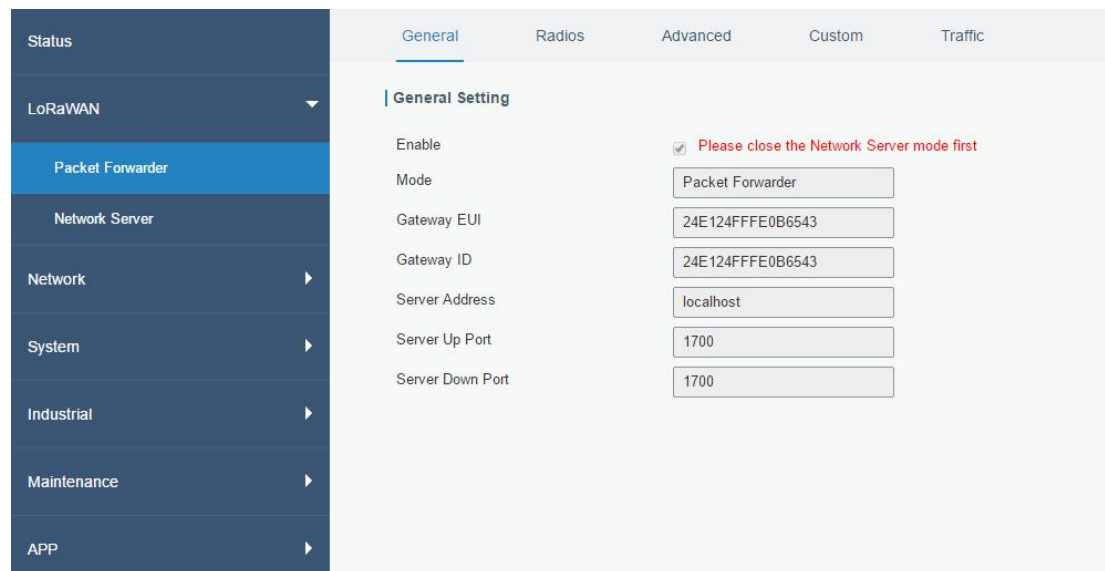

Figure 3-2-1-1

General Setting		
Item	Description	Default
Enable	Click to enable the Packet Forwarder mode.	Enabled
Gateway EUI	Show the identifier of the gateway.	Generated from MAC address of the gateway and cannot be changed.
Gateway ID	Fill in the corresponding ID which you've used for register gateway on the remote network server, such as TTN. It is usually the same with gateway EUI and can be changed.	The default is the same with gateway EUI.
Server Address	Enter the IP address of the LoRaWAN network server.	Null
Server Up Port	Enter the port of the LoRaWAN network server to upload data. Range: 1-65535.	1700
Server Down Port	Enter the port of the LoRaWAN network server to send data to your gateway. Range: 1-65535.	1700

Table 3-2-1-1 General Setting Parameters

3.2.1.2 Radios

Figure 3-2-1-2

Radios-Radio Channel Setting		
Item	Description	Default
Supported Frequency	Choose the LoRaWAN frequency plan used for the upstream and downlink frequencies and datarates. Available channel plans depend on the gateway’s variant.	The default frequency is set based on the gateway’s variant.
Name	Show the name of central frequency.	
Center Frequency	Enter the central frequency of Radio 0 which supports transmitting and receiving packet. Enter the center frequency of Radio 1 which only supports receiving packet from nodes.	Null

Table 3-2-1-2 Radio Channels Setting Parameters

Figure 3-2-1-3

Radios-Multi Channel Setting		
Item	Description	Default
Enable	Click to enable this channel to transmit packets.	Enabled
Index	Indicate the ordinal of the list.	
Radio	Choose Radio 0 or Radio 1 as center frequency.	Radio 0
Frequency/MHz	Enter the frequency of this channel. Range: center frequency ± 0.9 .	The default frequency is set based on the supported frequency you have selected.

Table 3-2-1-3 Multi Channel Setting Parameters

LoRa Channel Setting

Enable	Radio	Frequency/MHz	Bandwidth/KHz	Spread Factor
<input checked="" type="checkbox"/>	Radio 0	923.8	250KHZ	SF7

Figure 3-2-1-4

Radios-LoRa Channel Setting		
Item	Description	Default
Enable	Click to enable this channel to transmit packets.	Enabled
Radio	Choose Radio 0 or Radio 1 as center frequency.	Radio 0
Frequency/MHz	Enter the frequency of this channel. Range: center frequency \pm 0.9.	The default frequency is set based on the supported frequency you have selected.
Bandwidth/MHz	Enter the bandwidth of this channel. Recommended value: 125KHz, 250KHz, 500KHz	125KHz
Spread Factor	Choose the selectable spreading factor. The channel with large spreading factor corresponds to a low rate, while the small one corresponds to a high rate.	The default is based on what is specified in the LoRaWAN regional parameters document.

Table 3-2-1-4 LoRa Channel Setting Parameters

FSK Channel Setting

Enable	Radio	Frequency/MHz	Bandwidth/KHz	DataRate
<input checked="" type="checkbox"/>	Radio 0	924.0	125KHZ	50000

Figure 3-2-1-5

Radios-FSK Channel Setting		
Item	Description	Default
Enable	Click to enable this channel to transmit packets.	Disabled
Radio	Choose Radio 0 or Radio 1 as center frequency.	Radio 0
Frequency/MHz	Enter the frequency of this channel. Range: center frequency \pm 0.9.	The default frequency is set based on the supported frequency you have selected.
Bandwidth/MHz	Enter the bandwidth of this channel. Recommended value: 125KHz, 250KHz, 500KHz	500KHz
Data Rate	Enter the data rate. Range: 500-25000.	500

Table 3-2-1-5 FSK Channel Setting Parameters

3.2.1.3 Advanced

The screenshot shows the 'Advanced' configuration page. It features several sections: 'Intervals Setting' with input fields for 'Keep Alive Interval' (10 s), 'Stat Interval' (30 s), and 'Push Timeout' (100 ms); 'Forward CRC Setting' with checkboxes for 'Forward CRC Disabled' (unchecked), 'Forward CRC Error' (checked), and 'Forward CRC Valid' (checked); and 'Network Setting' with a dropdown menu for 'Network Mode' set to 'Private LoRaWAN'. A 'Save' button is located at the bottom left.

Figure 3-2-1-6

Advanced		
Item	Description	Default
Keep Alive Interval	Enter the interval of keepalive packet which is sent from gateway to LoRaWAN network server to keep the connection stable and alive. Range: 1-3600.	10
Stat Interval	Enter the interval to update the network server with gateway statistics. Range: 1-3600.	30
Push Timeout	Enter the timeout to wait for the response from server after the gateway sends data of node. Rang: 1-3600.	100
Forward CRC Disabled	Enable to send packets received with CRC disabled to the network server.	Disabled.
Forward CRC Error	Enable to send packets received with CRC errors to the network server.	Disabled.
Forward CRC Valid	Enable to send packets received with CRC valid to the network server.	Enabled
Network Mode	select from "Public LoRaWAN", "Private LoRaWAN". Public LoRaWAN: telecom/operator managed networks, connect multiple applications	Public LoRaWAN

	(multi-tenant) into a single network.	
	Private LoRaWAN: individually managed networks, Network deployed for single application purpose.	

Table 3-2-1-6 Advanced Parameters

3.2.1.4 Custom

General Radios Advanced **Custom** Traffic

Custom Configuration

Enable

[Example](#)

```
{
  "SX1301_conf": {
    "lorawan_public": true,
    "clksrc": 1, /* radio_1 provides clock to concentrator */
    "antenna_gain": 0, /* antenna gain, in dBi */
    "radio_0": {
      "enable": true,
      "type": "SX1257",
      "freq": 922500000,
      "rssi_offset": -162,
      "tx_enable": true,
      "tx_freq_min": 917000000,
      "tx_freq_max": 923500000
    },
    "radio_1": {
      "enable": true,
      "type": "SX1257"
    }
  }
}
```

Save & Apply Clear

Figure 3-2-1-7

When Custom Configuration mode is enabled, you can write your own packet forwarder configuration file in the edit box to configure packet forwarder. Click “Save” to save your custom configuration file content, and click “Apply” to take effect. You can click “Clear” to erase all content in the edit box. If you don’t know how to write configuration file, please click “Example” to go to reference page.

3.2.1.5 Traffic

When navigating to the traffic page, any recent traffic received by the gateway will display. To watch live traffic, click Start.

Traffic Setting								
Rfch	Direction	Time	Ticks	Frequency	Datarate	Coderate	RSSI	SNR
1	up	-	83002508	922.8	SF9BW125	4/5	-103	-13.2
1	up	-	71108156	922.6	SF9BW125	4/5	-102	-13.2
1	up	-	35426956	922.8	SF9BW125	4/5	-103	-9.8
1	up	-	3171639508	922.6	SF9BW125	4/5	-100	-10.5
1	up	-	3159744804	922.6	SF9BW125	4/5	-102	-13.0
1	up	-	3155781348	922.6	SF9BW125	4/5	-101	-12.2
1	up	-	3147851660	922.6	SF9BW125	4/5	-102	-13.8
1	up	-	3143888916	922.8	SF9BW125	4/5	-102	-13.2
1	up	-	3139922740	922.8	SF9BW125	4/5	-100	-12.2
1	up	-	3124065788	922.8	SF9BW125	4/5	-100	-12.8

Figure 3-2-1-8

Item	Description
Refresh	Click to obtain the latest data.
Clear	Click to clear all data.
Rfch	Show the channel of this packet.
Direction	Show the direction of this packet.
Time	Show the receiving time of this packet.
Ticks	Show the ticks of this packet.
Frequency	Show the frequency of the channel.
Datarate	Show the datarate of the channel.
Coderate	Show the coderate of this packet.
RSSI	Show the received signal strength.
SNR	Show the signal to noise ratio of this packet.

Table 3-2-1-7 Traffic Parameters

3.2.2 Network Server

3.2.2.1 General

Status

LoRaWAN

Packet Forwarder

Network Server

Network

System

Maintenance

APP

General Applications Profiles Device

General Setting

Enable

Mode Network Server

NetID 010203

Join Delay 5 sec

RX1 Delay 1 sec

Lease Time 744-0-0 hh-mm-ss

Log Level info

Channel Plan Setting

Channel Plan EU868

Channel Mask

Figure 3-2-2-1

Item	Description	Default
General Setting		
Enable	Click to enable Network Server mode.	Disabled
NetID	Enter the network identifier.	01023
Join Delay	Enter the interval time between the end-device sends a Join_request_message to network server and the end-device prepares to open RX1 to receive the Join_accept_message sent from network server.	5
RX1 Delay	Enter the interval time between the end-device sends uplink packets and the end-device prepares to open RX1 to receive the downlink packet.	1
Lease Time	Enter the amount of time until a successful join expires. The format is hours-minutes-seconds. If the join-type is OTAA, then the end-devices need to join the network server again when it exceeds the lease time.	"744-00-00"
Log level	Choose the log level.	Info
Channel Plan Setting		
Channel Plan	Choose LoRaWAN channel plan used for the upstream and downlink frequencies and datarates. Available channel plans depend on the gateway's variant.	Depend on the gateway's variant.
Channel Mask	<p>Enabled frequencies are controlled using channel mask.</p> <p>Leave it blank means using the default standard usable channels which are specified in the LoRaWAN regional parameters document.</p> <p>A bit in the ChMask field set to 1 means that the corresponding channel can be used for uplink transmissions if this channel allows the data rate currently used by the end-device.</p> <p>A bit set to 0 means the corresponding channels should be avoided.</p> <p>US and AU 915 have a 80-bit channel mask for 72 usable channels and EU, AS, IN, KR have a</p>	<p>Null.</p> <p>Null means using the default standard usable channels which are specified in the LoRaWAN regional parameters document.</p>

	16-bit mask for 16 usable channels.	
--	-------------------------------------	--

Table 3-2-2-1 General Parameters

Note: For some regional variants, If allowed by your LoRaWAN region, you can use Additional Plan to configure additional channels that are not defined by the LoRaWAN Regional Parameters, like EU868 and KR920, as the following picture shows:



Figure 3-2-2-2

Additional Channels		
Item	Description	Default
Frequency/MHz	Enter the frequency of the additional plan.	Null.
Max Datarate	Enter the max datarate for the end-device. The range is based on what is specified in the LoRaWAN regional parameters document.	DR0(SF12,125kHz)
Min Datarate	Enter the min datarate for the end-device. The range is based on what is specified in the LoRaWAN regional parameters document.	DR3(SF9,125kHz)

Table 3-2-2-2 Additional Plan Parameters

3.2.2.2 Application

Devices can communicate with applications that they’ve been registered. To register a device, you’ll first need to create an application (define the method you want to decode the data sent from end-device) and a device profile (define the join-type and LoRaWAN classes). You don’t have to create new application profile and device profile when you add a new device which its “Payload Codec”, “Join Type”, “Class Type” are the same with existing device. You can just choose the corresponding profiles.

You can see the information about the application you have created in this page.

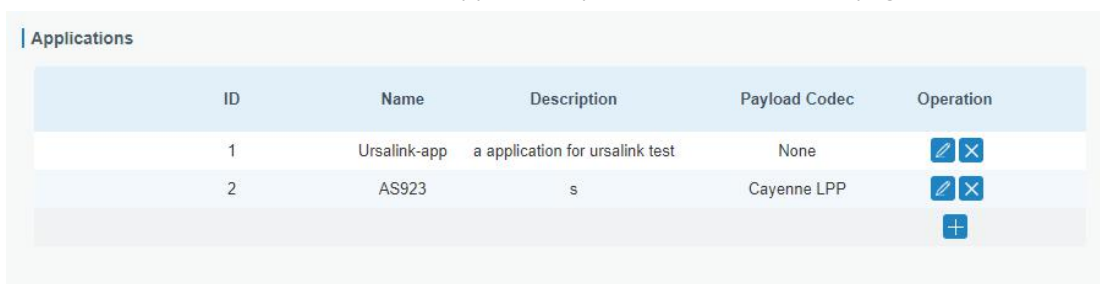

Figure 3-2-2-3

Item	Description
ID	Show the ID of the application profile already created.
Name	Show the name of the application profile already created.
Description	Show the description of the application profile already

	created.
Payload Codec	Show the payload codec of the application profile already created.

Table 3-2-2-3 Application Parameters

You can edit the application by clicking  or create a new application by clicking .

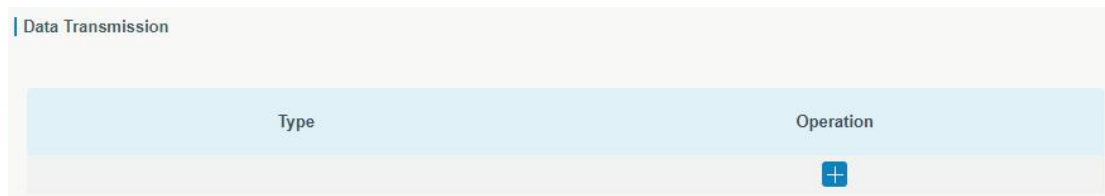

Figure 3-2-2-4

The data will be sent to your custom server address using the MQTT, HTTP or HTTPS protocol.

Related Configuration Example

[Application configuration](#)

3.2.2.3 Profiles

You can view the information about the device profiles which you have created in this page.







Name	Max TXPower	Join Type	Class Type	Operation
Device-test	0	OTAA	Class A	 
Ursalink-test-ABP	0	ABP	Class A	 
ninii	0	OTAA	Class A	 

Figure 3-2-2-5

Item	Description
Name	Show the name of the device profile.
Max Tx power	Show the Tx power of the device profile.
Join Type	Show the join type of the device profile.
Class Type	Show the class type of the device profile.

Table 3-2-2-4 Device profiles setting Parameters

You can edit the device profile by clicking  or create a new device profile by clicking .

Related Configuration Example

[Device Profiles Advanced configuraion](#)

3.2.2.4 Device

Device Name	Device EUI	Device-Profile	Application	Last Seen	Activated	Operation
asd	3530353083376118	ninii	AS923	53 minutes ago	✓	

Figure 3-2-2-6

Item	Description
Device Name	Show the name of the device.
Device EUI	Show the EUI of the device.
Device-Profile	Show the name of the device’s device profile.
Application	Show the name of the device’s application.
Last Seen	Show the time of last packet received.
Activated	Show the status of the device . means that the device has been activated.

Table 3-2-2-5 Device Parameters

You can edit the device by clicking or create a new device by clicking .

Related Configuration Example

[Device configuration](#)

3.2.2.5 Packets

Send Data To Device

Device EUI	Type	Payload	Port	Confirmed
<input type="text" value="0000000000000000"/>	ASCII	<input type="text"/>	<input type="text"/>	<input type="checkbox"/>

Network Server

Device EUI	Frequency	Datarate	SNR	RSSI	Size	Fcnt	Type	Time	Details
24e1641193199962	865402500	SF11BW125	-	-	17	0	JnAcc	2019-08-09T07:18:23+02:00	
24e1641193199962	865402500	SF11BW125	9.5	-34	18	0	JnReq	2019-08-09T07:18:22+02:00	
24e1641193199962	865402500	SF8BW125	-	-	0	2	DnUnc	2019-08-09T07:17:16+02:00	
24e1641193199962	865402500	SF8BW125	10.8	-42	26	3	UpCnf	2019-08-09T07:17:16+02:00	
24e1641193199962	865062500	SF7BW125	-	-	0	1	DnUnc	2019-08-09T07:17:01+02:00	
24e1641193199962	865062500	SF7BW125	8.8	-46	25	2	UpCnf	2019-08-09T07:17:01+02:00	
24e1641193199962	865402500	SF12BW125	-	-	0	0	DnUnc	2019-08-09T07:16:53+02:00	
24e1641193199962	865402500	SF12BW125	7.8	-50	3	1	UpCnf	2019-08-0	<input type="button" value="Manual Refresh"/> <input type="button" value="Refresh"/>

Figure 3-2-2-7

Send Data To Device		
Item	Description	Default
Device EUI	Enter the EUI of the device to receive the payload.	Null
Type	Choose from: "ASCII", "hex", "base64". Choose the payload type to enter in the payload Input box.	ASCII
Payload	Enter the message to be sent to this device.	Null
Fport	Enter the LoRaWAN frame port for packet transmission between device and Network Server.	Null
Confirmed	After enabled, the end device will receive downlink packet and should answer "confirmed" to the network server.	Disabled

Network Server	
Item	Description
Device EUI	Show the EUI of the device.
Frequency	Show the used frequency to transmit packets.
Datarate	Show the used datarate to transmit packets.
SNR	Show the signal-noise ratio.
RSSI	Show the received signal strength indicator.
Size	Show the size of payload.
Fcnt	Show the frame counter.
Type	Show the type of the packet: JnAcc - Join Accept Packet JnReq - Join Request Packet UpUnc - Uplink Unconfirmed Packet UpCnf - Uplink Confirmed Packet - ACK response from network requested DnUnc - Downlink Unconfirmed Packet DnCnf - Downlink Confirmed Packet- ACK response from end-device requested
Time	Show the time of packet was sent or received.

Table 3-2-2-6 Packet Parameters

Click  to get more details about the packet. As shown:

Packets Details	
Dev Addr	068c1b56
GwEUI	24e124ffe0b7443
AppEUI	70b3d57ed0007ac1
DevEUI	3530353083376118
Immediately	false
TimeSinceGPSEpoch	-
Timestamp	242616788
Type	DnUnc
Adr	true
AdrAckReq	false
Ack	true
Fcnt	-
Fport	-

Figure 3-2-2-8

Item	Description
Dev Addr	Show the address of the device.
GwEUI	Show the EUI of the gateway.
AppEUI	Show the EUI of the application.
DevEUI	Show the EUI of the device.
Immediately	True: Device may transmit an explicit (possibly empty) acknowledgement data message immediately after the reception of a data message requiring a confirmation.
TimeSinceGPS Epoch	Show the GPS time.
Timestamp	Show the timestamp of this packet.
Frequency	Show the frequency of this channel.
Type	Show the type of the packet: JnAcc - Join Accept Packet JnReq - Join Request Packet UpUnc - Uplink Unconfirmed Packet UpCnf - Uplink Confirmed Packet - ACK response from network requested DnUnc - Downlink Unconfirmed Packet DnCnf - Downlink Confirmed Packet- ACK response from end-device requested
Adr	True: The end-node has enabled ADR. False: The end-node has not enabled ADR.
AdrAckReq	In order to validate that the network is receiving the uplink messages, nodes periodically transmit ADRAckReq message. This is 1 bit long. True: Network should respond in ADR_ACK_DELAY time to confirm that it

	is receiving the uplink messages False: Otherwise
Ack	True: This frame is ACK. False: This frame is not ACK.
Fcnt	Show the frame-counter of this packet.The network server tracks the uplink frame counter and generates the downlink counter for each end-device.
FPort	FPort is a multiplexing port field. If the frame payload field is not empty, the port field must be present. If present, a FPort 16 value of 0 indicates that the FRMPayload contains MAC commands only.When this is the case, the FOptsLen field must be zero. FOptsLen is the length of the FOpts field in bytes.
Modulation	LoRa means the physical layer uses the LoRa modulation
Bandwidth	Show the bandwidth of this channel.
SpreadFactor	Show the spreadFactor of this channel.
Bitrate	Show the bitrate of this channel.
CodeRate	Show the coderate of this channel.
SNR	Show the SNR of this channel.
RSSI	Show the RSSI of this channel.
Power	Show the transmit power of the device.
Payload (b64)	Show the application payload of this packet.
Payload (hex)	Show the application payload of this packet.
MIC	Show the MIC of this packet.MIC is a cryptographic message integrity code, computed over the fields MHDR, FHDR, FPort and the encrypted FRMPayload.

Table 3-2-2-7 Packets Details Parameters

Related Topic

[Send Data to Device](#)

3.3 Network

3.3.1 Interface

3.3.1.1 Port

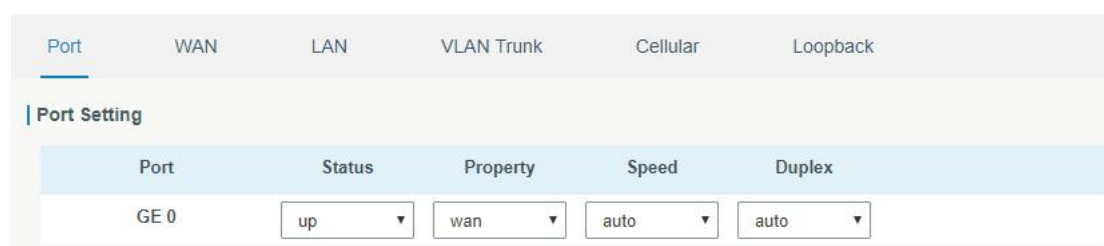

Figure 3-3-1-1

Port Setting	
Item	Description
Port	Users can define the Ethernet ports according to their needs.
Status	Set the status of Ethernet port; select "up" to enable and "down" to disable.
Property	LAN. User cannot change this setting.
Speed	Set the Ethernet port's speed. The options are "auto", "1000 Mbps", "100 Mbps", and "10 Mbps".
Duplex	Set the Ethernet port's mode. The options are "auto", "full", and "half".

Table 3-3-1-1 Port Parameters

3.3.1.2 WAN

WAN port can be connected with Ethernet cable to get Internet access. It supports 3 connection types.

- **Static IP:** configure IP address, netmask and gateway for Ethernet WAN interface.
- **DHCP Client:** configure Ethernet WAN interface as DHCP Client to obtain IP address automatically.
- **PPPoE:** configure Ethernet WAN interface as PPPoE Client.



For your device security, please change the default password

Status

LoRaWAN

Network

Interface

Firewall

QoS

DHCP

DDNS

Link Failover

VPN

Port WAN LAN VLAN Trunk Cellular Loopback

WAN_1

Enable

Port

Connection Type

IP Address

Netmask

Gateway

MTU

Primary DNS Server

Secondary DNS Server

Enable NAT

Figure 3-3-1-2

WAN Setting		
Item	Description	Default
Enable	Enable WAN function	Enable
Port	The port that is currently set as WAN port.	GE 0
Connection	Select from "Static IP", "DHCP Client" and "PPPoE".	Static IP

Type		
MTU	Set the maximum transmission unit.	1500
Primary DNS Server	Set the primary DNS.	Null
Secondary DNS Server	Set the secondary DNS.	Null
Enable NAT	Enable or disable NAT function. When enabled, a private IP can be translated to a public IP.	Enable

Table 3-3-1-2 WAN Parameters

1. Static IP Configuration

If the external network assigns a fixed IP for the WAN interface, user can select “Static IP” mode.

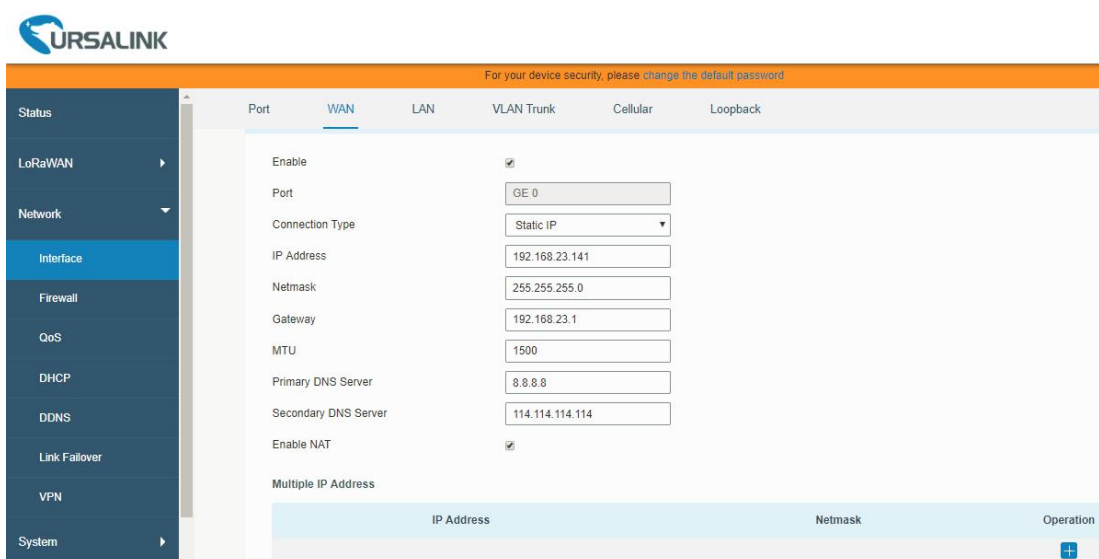

Figure 3-3-1-3

Static IP		
Item	Description	Default
IP Address	Set the IP address which can access Internet. E.g. 192.168.1.2.	192.168.0.1
Netmask	Set the Netmask for WAN port.	255.255.255.0
Gateway	Set the gateway's IP address for WAN port.	192.168.0.2
Multiple IP Address	Set the multiple IP addresses for WAN port.	Null

Table 3-3-1-3 Static Parameters

2. DHCP Client

If the external network has DHCP server enabled and has assigned IP addresses to the Ethernet WAN interface, user can select “DHCP client” mode to obtain IP address automatically.

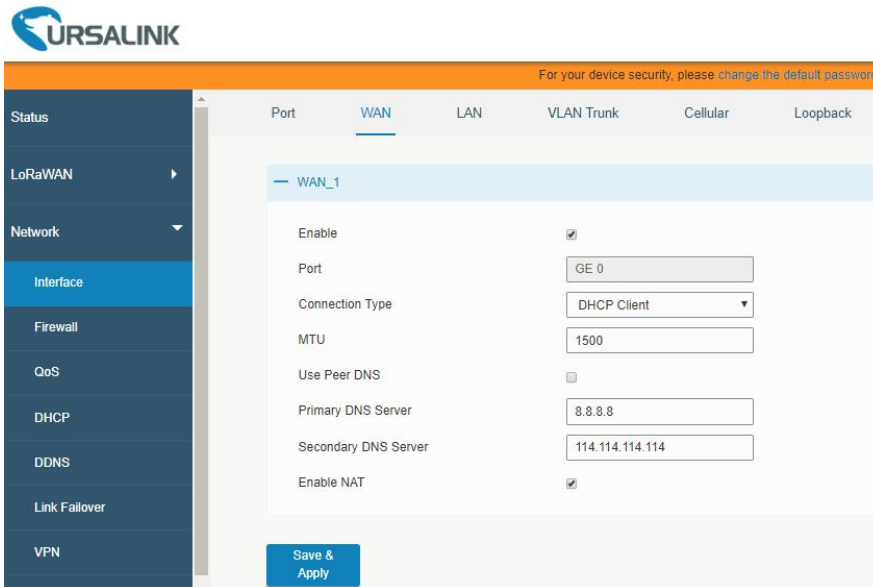

Figure 3-3-1-4

DHCP Client	
Item	Description
Use Peer DNS	Obtain peer DNS automatically during PPP dialing. DNS is necessary when user visits domain name.

Table 3-3-1-4 DHCP Client Parameters

3. PPPoE

PPPoE refers to a point to point protocol over Ethernet. User has to install a PPPoE client on the basis of original connection way. With PPPoE, remote access devices can get control of each user.

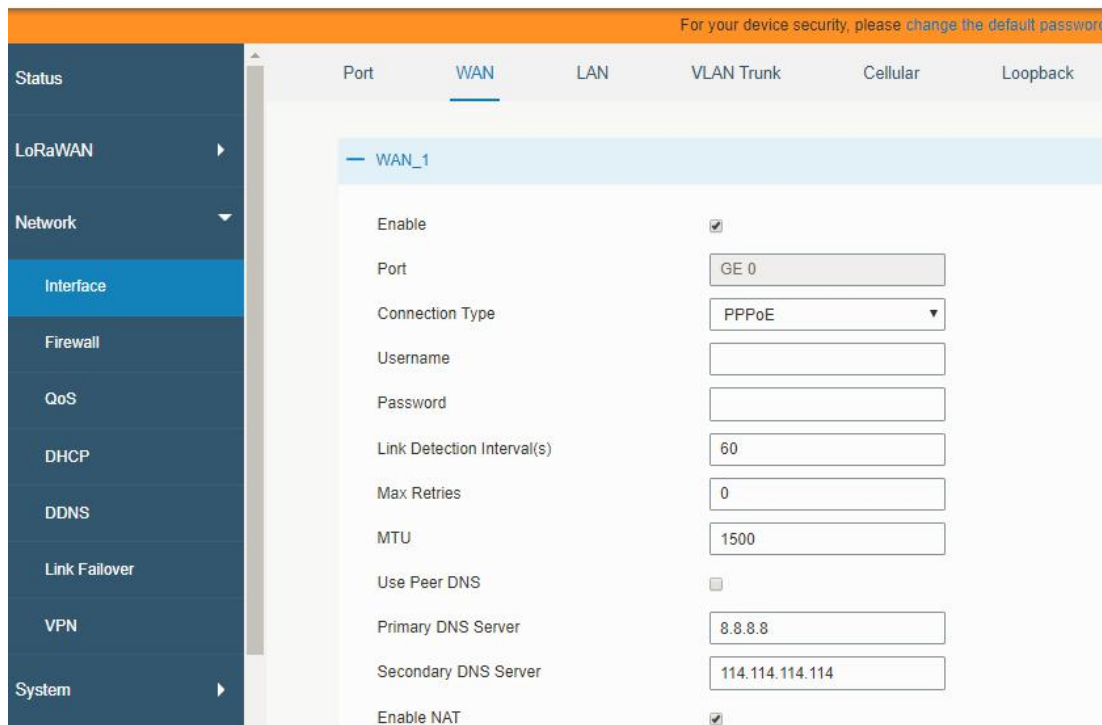

Figure 3-3-1-5

PPPoE	
Item	Description
Username	Enter the username provided by your Internet Service Provider (ISP).
Password	Enter the password provided by your Internet Service Provider (ISP).
Link Detection Interval (s)	Set the heartbeat interval for link detection. Range: 1-600.
Max Retries	Set the maximum retry times after it fails to dial up. Range: 0-9.
Use Peer DNS	Obtain peer DNS automatically during PPP dialing. DNS is necessary when user visits domain name.

Table 3-3-1-5 PPOE Parameters

3.3.1.3 LAN

LAN setting is used for managing local area network devices connected to LAN port of the UG87, allowing each device to access the Internet.

Click  to delete the existing LAN port setting. Click  to add a new LAN port setting.

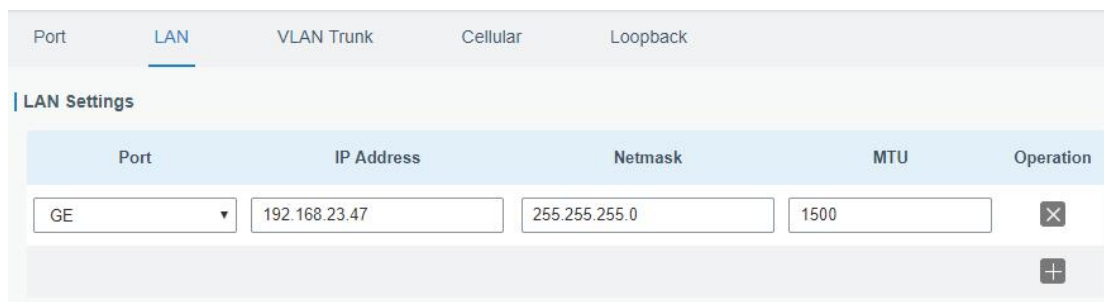

Figure 3-3-1-6

LAN		
Item	Description	Default
Port	Select LAN port.	GE
IP Address	Set IP address of LAN port.	192.168.1.1
Netmask	Set Netmask of LAN port.	255.255.255.0
MTU	Set the maximum transmission unit of LAN port. Range: 68-1500.	1500

Table 3-3-1-6

3.3.1.4 VLAN Trunk

VLAN is a kind of new data exchange technology that realizes virtual work groups by logically dividing the LAN device into network segments.



Client  to delete the current VLAN setting. Click  to add a new VLAN port.



Figure 3-3-1-7

VLAN Trunk	
Item	Description
Enable	The gateway can encapsulate or decapsulate the virtual LAN tag when this function is enabled.
Interface	Select the VLAN interface from the LAN ports.
VID	Set the label ID of the VLAN. Range: 1-4094.
IP Address	Set VLAN port's IP address.
Netmask	Set VLAN port's netmask.

Table 3-3-1-7 VLAN Trunk Parameters

3.3.1.5 WLAN (Only Applicable to Wi-Fi Version)

This section explains how to set the related parameters for Wi-Fi network. UG87 supports 802.11 b/g/n/ac, as AP or client mode.

Port	WAN	LAN	VLAN Trunk	WLAN	Cellular	Loopback
WLAN						
Enable		<input checked="" type="checkbox"/>				
Work Mode		AP				
SSID Broadcast		<input checked="" type="checkbox"/>				
AP Isolation		<input type="checkbox"/>				
Radio Type		802.11ac				
Channel		Auto				
SSID		test				
BSSID		24:e1:24:f0:00:f3				
Encryption Mode		No Encryption				
Bandwidth		80MHz				
Max Client Number		100				

Figure 3-2-1-8

IP Setting	
Protocol	Static IP
IP Address	192.168.232.1
Netmask	255.255.255.0

Figure 3-2-1-9

WLAN Settings	
Item	Description
Enable	Enable/disable WLAN.
Work Mode	Select gateway's work mode. The options are "Client" or "AP".
Encryption Mode	Select encryption mode. The options are "No Encryption", "WEP Open System", "WEP Shared Key", "WPA-PSK", "WPA2-PSK" and "WPA-PSK/WPA2-PSK".
BSSID	Fill in the MAC address of the access point. Either SSID or BSSID can be filled to joint the network.

SSID	Fill in the SSID of the access point.
Client Mode	
Scan	Click "Scan" button to search the nearby access point.
SSID	Show SSID.
Channel	Show wireless channel.
Signal	Show wireless signal.
BSSID	Show the MAC address of the access point.
Security	Show the encryption mode.
Frequency	Show the frequency of radio.
Join Network	Click the button to join the wireless network.
AP Mode	
SSID Broadcast	When SSID broadcast is disabled, other wireless devices can't not find the SSID, and users have to enter the SSID manually to access to the wireless network.
AP Isolation	When AP isolation is enabled, all users which access to the AP are isolated without communication with each other.
Radio Type	Select Radio type. The options are "802.11b (2.4 GHz)", "802.11g (2.4 GHz)", "802.11n (2.4 GHz)", "802.11 n (5 GHz)" and "802.11 ac (5 GHz)".
Channel	Select wireless channel. The options are "Auto", "1", "2"....."13".
Cipher	Select cipher. The options are "Auto", "AES", "TKIP" and "AES/TKIP".
Key	Fill the pre-shared key of WPA encryption.
Bandwidth	Select bandwidth. The options are "20MHz" and "40MHz".
Max Client Number	Set the maximum number of client to access when the gateway is configured as AP.
IP Setting	
Protocol	Set the IP address in wireless network.
IP Address	Set the IP address in wireless network.
Netmask	Set the netmask in wireless network.
Gateway	Set the gateway in wireless network.

Table 3-3-1-8 WLAN Parameters

Related Topic

[Wi-Fi Application Example](#)

3.3.1.6 Cellular

This section explains how to set the related parameters for cellular network. The UG87 LoRaWAN gateway has two cellular interfaces, namely SIM1 and SIM2. Only one cellular interface is active at one time. If both cellular interfaces are enabled, then SIM1 interface takes precedence by default.

A typical use case would be to have SIM1 configured as the primary cellular interface and SIM2 as a backup. If the UG87 cannot connect to the network via SIM1, it will automatically

fail over to SIM2.

Port	WAN	LAN	VLAN Trunk	Cellular	Loopback
Cellular Setting					
				SIM1	SIM2
Enable				<input checked="" type="checkbox"/>	<input checked="" type="checkbox"/>
Network Type				<input type="text"/>	<input type="text"/>
APN				<input type="text"/>	<input type="text"/>
Username				<input type="text"/>	<input type="text"/>
Password				<input type="text"/>	<input type="text"/>
Access Number				<input type="text"/>	<input type="text"/>
PIN Code				<input type="text"/>	<input type="text"/>
Authentication Type				Auto	Auto
Roaming				<input type="checkbox"/>	<input type="checkbox"/>
SMS Center				<input type="text"/>	<input type="text"/>

Figure 3-3-1-10

Connection Setting	<input type="checkbox"/>
Dual SIM Strategy	<input type="checkbox"/>
Enable NAT	<input checked="" type="checkbox"/>
Restart When Dial-up failed	<input type="checkbox"/>
ICMP Server	<input type="text" value="8.8.8.8"/>
Secondary ICMP Server	<input type="text" value="114.114.114.114"/>
PING Times	<input type="text" value="5"/>
Packet Loss Rate	<input type="text" value="20"/> %
SMS Settings	
SMS Mode	PDU

Figure 3-3-1-11

General Settings		
Item	Description	Default
Enable	Check the option to enable the corresponding SIM card.	Enable
Network Type	Select from "Auto", "4G First", "4G Only", "3G First", "3G Only", "2G First", and "2G Only". Auto: connect to the network with the strongest signal automatically.	Auto

	4G First: 4G network takes precedence. 4G Only: connect to 4G network only. And so on.	
APN	Enter the Access Point Name for cellular dial-up connection provided by local ISP.	Null
Username	Enter the username for cellular dial-up connection provided by local ISP.	Null
Password	Enter the password for cellular dial-up connection provided by local ISP.	Null
Access Number	Enter the dial-up center NO. For cellular dial-up connection provided by local ISP.	Null
PIN Code	Enter a 4-8 characters PIN code to unlock the SIM.	Null
Authentication Type	Select from "Auto", "PAP", "CHAP", "MS-CHAP", and "MS-CHAPv2".	Auto
Roaming	Enable or disable roaming.	Disable
SMS Center	Enter the local SMS center number for storing, forwarding, converting and delivering SMS message.	Null
Enable NAT	Enable or disable NAT function.	Enable
Restart When Dial-up failed	When this function is enabled, the gateway will restart automatically if the dial-up fails several times.	Disabled
ICMP Server	Set the ICMP detection server's IP address.	8.8.8.8
Secondary ICMP Server	Set the secondary ICMP detection server's IP address.	114.114.114.114
PING Times	Set PING packet numbers in each ICMP detection.	5
Packet Loss Rate	Set packet loss rate in each ICMP detection. ICMP detection fails when the preset packet loss rate is exceeded.	20

Table 3-3-1-9 Cellular Parameters

Connection Setting	<input checked="" type="checkbox"/>
Connection Mode	Connect on Demand ▼
Redial Interval(s)	5
Max Idle Time(s)	60
Triggered by Call	<input type="checkbox"/>
Triggered by SMS	<input type="checkbox"/>
Triggered by IO	<input type="checkbox"/>
Dual SIM Strategy	<input checked="" type="checkbox"/>
Primary SIM Card	SIM1 ▼
Switch to backup SIM card when ICMP detection fails	<input checked="" type="checkbox"/>
Switch to backup SIM card when the connection fails	<input checked="" type="checkbox"/>
Switch to backup SIM card when roaming is detected	<input type="checkbox"/>

Figure 3-3-1-12

Item	Description
Connection Mode	
Connection Mode	Select from "Always Online" and "Connect on Demand".
Connect on Demand	"Connect on Demand" includes "Triggered by Call", "Triggered by SMS", and "Triggered by IO".
Triggered by Call	The gateway will switch from offline mode to cellular network mode automatically when it receives a call from the specific phone number.
Call Group	Select a call group for call trigger. Go to "System > General > Phone" to set up phone group.
Triggered by SMS	The gateway will switch from offline mode to cellular network mode automatically when it receives a specific SMS from the specific mobile phone.
SMS Group	Select a SMS group for trigger. Go to "System > General > Phone" to set up SMS group.
SMS Text	Fill in the SMS content for triggering.
Triggered by IO	The gateway will switch from offline mode to cellular network mode automatically when the DI status is changed. Go to "Industrial > I/O > DI" to configure trigger condition.
Dual SIM Strategy	
Current SIM Card	Select between "SIM1" and "SIM2" as a current SIM card used.
Switch to backup SIM card when ICMP detection fails	The gateway will switch to the backup SIM card when packet loss rate in ICMP detection exceeds the preset value.
Switch to backup	The gateway will switch to the backup SIM card when the primary

SIM card when the connection fails	one fails to connect with cellular network.
Switch to backup SIM card when roaming is detected	The gateway will switch to the backup SIM card when the primary one is roaming.

Table 3-3-1-10 Cellular Parameters

Related Topics

[Cellular Connection Application Example](#)

[Dual SIM Backup Application Example](#)

[Phone Group](#)

3.3.1.7 Loopback

Loopback interface is used for replacing gateway's ID as long as it is activated. When the interface is DOWN, the ID of the gateway has to be selected again which leads to long convergence time of OSPF. Therefore, Loopback interface is generally recommended as the ID of the gateway.

Loopback interface is a logic and virtual interface on gateway. Under default conditions, there's no loopback interface on gateway, but it can be created as required.

Figure 3-3-1-13

Loopback		
Item	Description	Default
IP Address	Unalterable	127.0.0.1
Netmask	Unalterable	255.0.0.0
Multiple IP Addresses	Apart from the IP above, user can configure other IP addresses.	Null

Table 3-3-1-11 Loopback Parameters

3.3.2 Firewall

This section describes how to set the firewall parameters, including website block, ACL, DMZ, Port Mapping and MAC Binding.

The firewall implements corresponding control of data flow at entry direction (from Internet to local area network) and exit direction (from local area network to Internet) according to the content features of packets, such as protocol style, source/destination IP address, etc. It ensures that the gateway operate in a safe environment and host in local area network.

3.3.2.1 Security

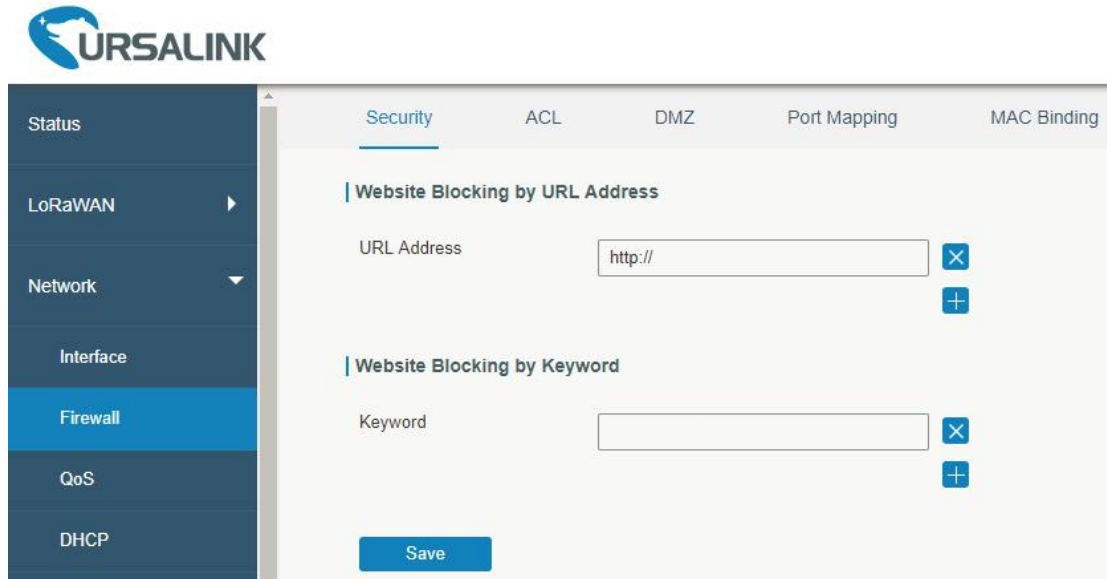

Figure 3-3-2-1

Website Blocking	
URL Address	Enter the HTTP address which you want to block.
Keyword	You can block specific website by entering keyword. The maximum number of character allowed is 64.

Table 3-2-2-1 Security Parameters

3.3.2.2 ACL

Access control list, also called ACL, implements permission or prohibition of access for specified network traffic (such as the source IP address) by configuring a series of matching rules so as to filter the network interface traffic. When gateway receives packet, the field will be analyzed according to the ACL rule applied to the current interface. After the special packet is identified, the permission or prohibition of corresponding packet will be implemented according to preset strategy.

The data package matching rules defined by ACL can also be used by other functions requiring flow distinction.

Figure 3-3-2-2

Item	Description
ACL Setting	
Default Filter Policy	Select from "Accept" and "Deny". The packets which are not included in the access control list will be processed by the default filter policy.
Access Control List	
Type	Select type from "Extended" and "Standard".
ID	User-defined ACL number. Range: 1-199.
Action	Select from "Permit" and "Deny".
Protocol	Select protocol from "ip", "icmp", "tcp", "udp", and "1-255".
Source IP	Source network address (leaving it blank means all).
Source Wildcard Mask	Wildcard mask of the source network address.
Destination IP	Destination network address (0.0.0.0 means all).
Destination Wildcard Mask	Wildcard mask of destination address.
Description	Fill in a description for the groups with the same ID.
ICMP Type	Enter the type of ICMP packet. Range: 0-255.
ICMP Code	Enter the code of ICMP packet. Range: 0-255.
Source Port Type	Select source port type, such as specified port, port range, etc.
Source Port	Set source port number. Range: 1-65535.
Start Source Port	Set start source port number. Range: 1-65535.
End Source Port	Set end source port number. Range: 1-65535.
Destination Port Type	Select destination port type, such as specified port, port range, etc.
Destination Port	Set destination port number. Range: 1-65535.

Start Destination Port	Set start destination port number. Range: 1-65535.
End Destination Port	Set end destination port number. Range: 1-65535.
More Details	Show information of the port.
Interface List	
Interface	Select network interface for access control.
In ACL	Select a rule for incoming traffic from ACL ID.
Out ACL	Select a rule for outgoing traffic from ACL ID.

Table 3-3-2-2 ACL Parameters

3.3.2.3 DMZ

DMZ is a host within the internal network that has all ports exposed, except those forwarded ports in port mapping.

Figure 3-3-2-3

DMZ	
Item	Description
Enable	Enable or disable DMZ.
DMZ Host	Enter the IP address of the DMZ host on the internal network.
Source Address	Set the source IP address which can access to DMZ host. "0.0.0.0/0" means any address.

Table 3-3-2-3 DMZ Parameters

3.3.2.4 Port Mapping

Port mapping is an application of network address translation (NAT) that redirects a communication request from the combination of an address and port number to another while the packets are traversing a network gateway such as a gateway or firewall.

Click  to add a new port mapping rules.

Figure 3-3-2-4

Port Mapping	
Item	Description
Source IP	Specify the host or network which can access local IP address. 0.0.0.0/0 means all.
Source Port	Enter the TCP or UDP port from which incoming packets are forwarded. Range: 1-65535.
Destination IP	Enter the IP address that packets are forwarded to after being received on the incoming interface.
Destination Port	Enter the TCP or UDP port that packets are forwarded to after being received on the incoming port(s). Range: 1-65535.
Protocol	Select from "TCP" and "UDP" as your application required.
Description	The description of this rule.

Table 3-3-2-4 Port Mapping Parameters

Related Configuration Example

[NAT Application Example](#)

3.3.2.5 MAC Binding

MAC Binding is used for specifying hosts by matching MAC addresses and IP addresses that are in the list of allowed outer network access.

Figure 3-3-2-5

MAC Binding List	
Item	Description
MAC Address	Set the binding MAC address.
IP Address	Set the binding IP address.
Description	Fill in a description for convenience of recording the meaning of the binding rule for each piece of MAC-IP.

Table 3-3-2-5 MAC Binding Parameters

3.3.3 QoS

Quality of service (QoS) refers to traffic prioritization and resource reservation control mechanisms rather than the achieved service quality. QoS is engineered to provide different priority for different applications, users, data flows, or to guarantee a certain level of performance to a data flow.

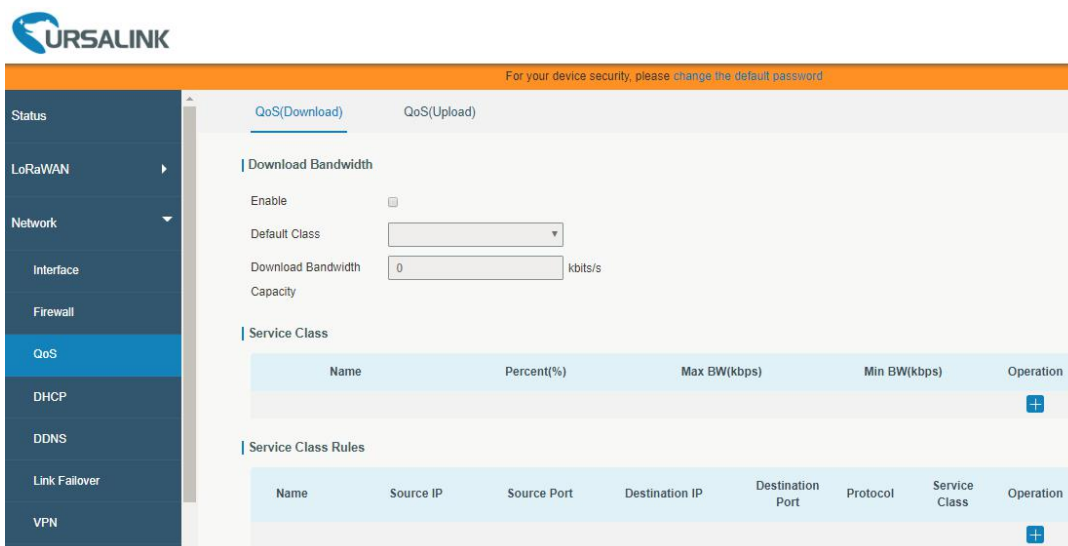

Figure 3-3-3-1

QoS	
Item	Description
Download/Upload	
Enable	Enable or disable QoS.
Default Class	Select default class from Service Class list.
Download/Upload Bandwidth Capacity	The download/upload bandwidth capacity of the network that the gateway is connected with, in kbps. Range: 1-8000000.
Service Classes	
Name	Give the service class a descriptive name.
Percent (%)	The amount of bandwidth that this class should be guaranteed in percentage. Range: 0-100.
Max BW(kbps)	The maximum bandwidth that this class is allowed to consume, in kbps. The value should be less than the "Download/Upload Bandwidth Capacity".

Min BW(kbps)	The minimum bandwidth that can be guaranteed for the class, in kbps. The value should be less than the "MAX BW" value.
Service Class Rules	
Item	Description
Name	Give the rule a descriptive name.
Source IP	Source address of flow control (leaving it blank means any).
Source Port	Source port of flow control. Range: 0-65535 (leaving it blank means any).
Destination IP	Destination address of flow control (leaving it blank means any).
Destination Port	Destination port of flow control. Range: 0-65535 (leaving it blank means any).
Protocol	Select protocol from "ANY", "TCP", "UDP", "ICMP", and "GRE".
Service Class	Set service class for the rule.

Table 3-3-3-1 QoS (Download/Upload) Parameters

3.3.4 DHCP

DHCP adopts Client/Server communication mode. The Client sends configuration request to the Server which feeds back corresponding configuration information and distributes IP address to the Client so as to achieve the dynamic configuration of IP address and other information.

3.3.4.1 DHCP Server

The UG87 can be set as a DHCP server to distribute IP address when a host logs on and ensures each host is supplied with different IP addresses. DHCP Server has simplified some previous network management tasks requiring manual operations to the largest extent.

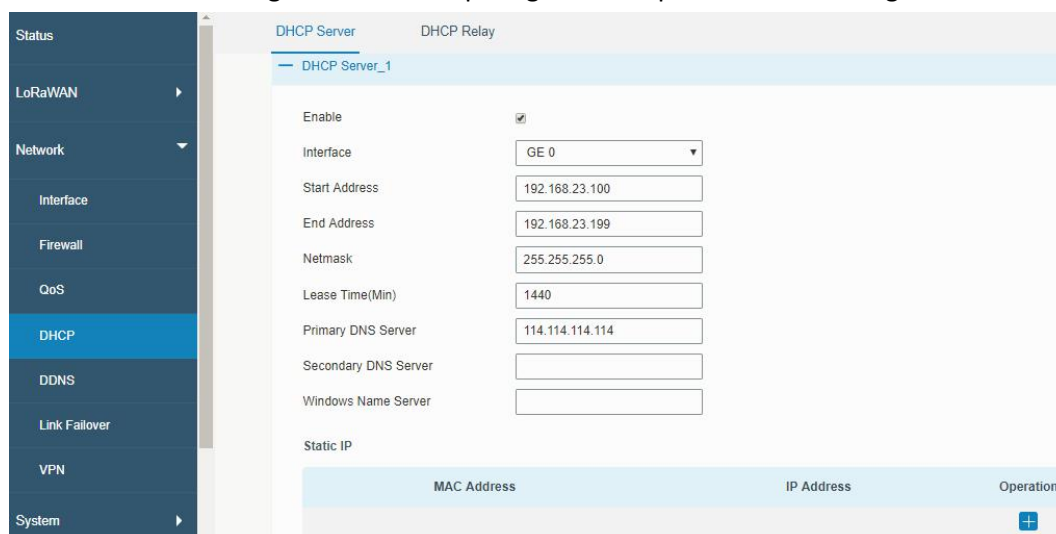

Figure 3-3-4-1

DHCP Server		
Item	Description	Default
Enable	Enable or disable DHCP server.	Enable
Interface	Select interface, e.g. GE.	GE
Start Address	Define the beginning of the pool of IP addresses which will be leased to DHCP clients.	192.168.1.100
End Address	Define the end of the pool of IP addresses which will be leased to DHCP clients.	192.168.1.199
Netmask	Define the subnet mask of IP address obtained by DHCP clients from DHCP server.	255.255.255.0
Lease Time (Min)	Set the lease time on which the client can use the IP address obtained from DHCP server. Range: 1-10080.	1440
Primary DNS Server	Set the primary DNS server.	114.114.114.114
Secondary DNS Server	Set the secondary DNS server.	Null
Windows Name Server	Define the Windows Internet Naming Service obtained by DHCP clients from DHCP sever. Generally you can leave it blank.	Null
Static IP		
MAC Address	Set a static and specific MAC address for the DHCP client (it should be different from other MACs so as to avoid conflict).	Null
IP Address	Set a static and specific IP address for the DHCP client (it should be outside of the DHCP range).	Null

Table 3-3-4-1 DHCP Server Parameters

3.3.4.2 DHCP Relay

The UG87 can be set as DHCP Relay to provide a relay tunnel to solve the problem that DHCP Client and DHCP Server are not in the same subnet.



Figure 3-3-4-2

DHCP Relay	
Item	Description
Enable	Enable or disable DHCP relay.
DHCP Server	Set DHCP server, up to 10 servers can be configured; separate them by blank space or ",".

Table 3-3-4-2 DHCP Relay Parameters

3.3.5 DDNS

Dynamic DNS (DDNS) is a method that automatically updates a name server in the Domain Name System, which allows user to alias a dynamic IP address to a static domain name.

DDNS serves as a client tool and needs to coordinate with DDNS server. Before starting configuration, user shall register on a website of proper domain name provider and apply for a domain name.

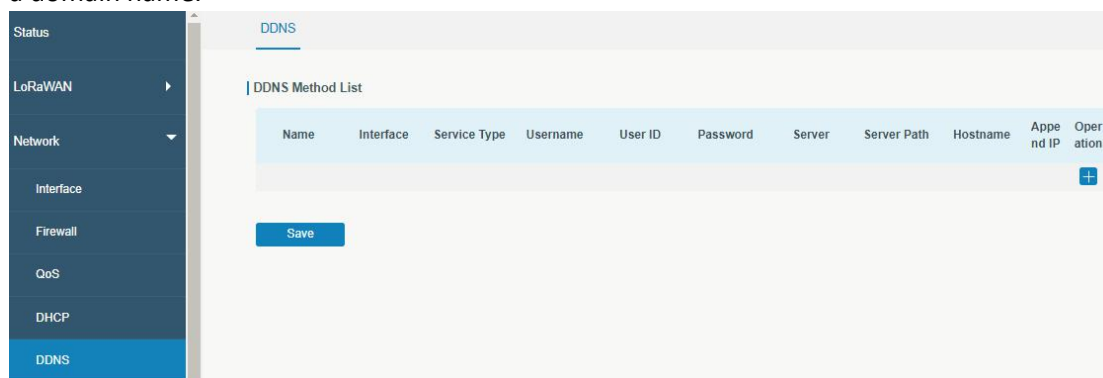

Figure 3-3-5-1

DDNS	
Item	Description
Name	Give the DDNS a descriptive name.
Interface	Set interface bundled with the DDNS.
Service Type	Select the DDNS service provider.
Username	Enter the username for DDNS register.
User ID	Enter User ID of the custom DDNS server.
Password	Enter the password for DDNS register.
Server	Enter the name of DDNS server.
Hostname	Enter the hostname for DDNS.
Append IP	Append your current IP to the DDNS server update path.

Table 3-3-5-1 DDNS Parameters

3.3.6 Link Failover

This section describes how to configure link failover strategies, such as VRRP strategies.

Configuration Steps

1. Define one or more SLA operations (ICMP probe).
2. Define one or more track objects to track the status of SLA operation.
3. Define applications associated with track objects, such as VRRP or static routing.

3.3.6.1 SLA

SLA setting is used for configuring link probe method. The default probe type is ICMP.

Figure 3-3-6-1

SLA		
Item	Description	Default
ID	SLA index. Up to 10 SLA settings can be added. Range: 1-10.	1
Type	ICMP-ECHO is the default type to detect if the link is alive.	icmp-echo
Destination Address	The detected IP address.	114.114.114.114
Secondary Destination Address	The secondary detected IP address.	8.8.8.8
Data Size	User-defined data size. Range: 0-1000.	56
Interval (s)	User-defined detection interval. Range: 1-608400.	30
Timeout (ms)	User-defined timeout for response to determine ICMP detection failure. Range: 1-300000.	5000
PING Times	Define PING packet numbers in each SLA probe. Range: 1-1000.	5
Packet Loss Rate	Define packet loss rate in each SLA probe. SLA probe fails when the preset packet loss rate is exceeded.	20
Start Time	Detection start time; select from "Now" and blank character. Blank character means this SLA detection doesn't start.	now

Table 3-3-6-1 SLA Parameters

3.3.6.2 Track

Track setting is designed for achieving linkage among SLA module, Track module and Application module. Track setting is located between application module and SLA module with main function of shielding the differences of various SLA modules and providing unified interfaces for application module.

Linkage between Track Module and SLA module

Once you complete the configuration, the linkage relationship between Track module and SLA module will be established. SLA module is used for detection of link status, network performance and notification of Track module. The detection results help track status change

timely.

- For successful detection, the corresponding track item is Positive.
- For failed detection, the corresponding track item is Negative.

Linkage between Track Module and Application Module

After configuration, the linkage relationship between Track module and Application module will be established. When any change occurs in track item, a notification that requires corresponding treatment will be sent to Application module.

Currently, the application modules like VRRP and static routing can get linkage with track module.

If it sends an instant notification to Application module, the communication may be interrupted in some circumstances due to routing's failure like timely restoration or other reasons. Therefore, user can set up a period of time to delay notifying application module when the track item status changes.

ID	Type	SLA ID	Interface	Negative Delay(s)	Positive Delay(s)	Operation
1	sla	1	cellular0	0	1	[X] [+]

Figure 3-3-6-2

Item	Description	Default
Index	Track index. Up to 10 track settings can be configured. Range: 1-10.	1
Type	The options are "sla" and "interface".	SLA
SLA ID	Defined SLA ID.	1
Interface	Select the interface whose status will be detected.	cellular0
Negative Delay (s)	When interface is down or SLA probing fails, it will wait according to the time set here before actually changing its status to Down. Range: 0-180 (0 refers to immediate switching).	0
Positive Delay (s)	When failure recovery occurs, it will wait according to the time set here before actually changing its status to Up. Range: 0-180 (0 refers to immediate switching).	1

Table 3-3-6-2 Track Parameters

3.3.6.3 VRRP

The Virtual Router Redundancy Protocol (VRRP) is a computer networking protocol that provides automatic assignment of available Internet Protocol (IP) routers for participating

hosts. This increases the availability and reliability of routing paths via automatic default gateway selections in an IP sub-network.

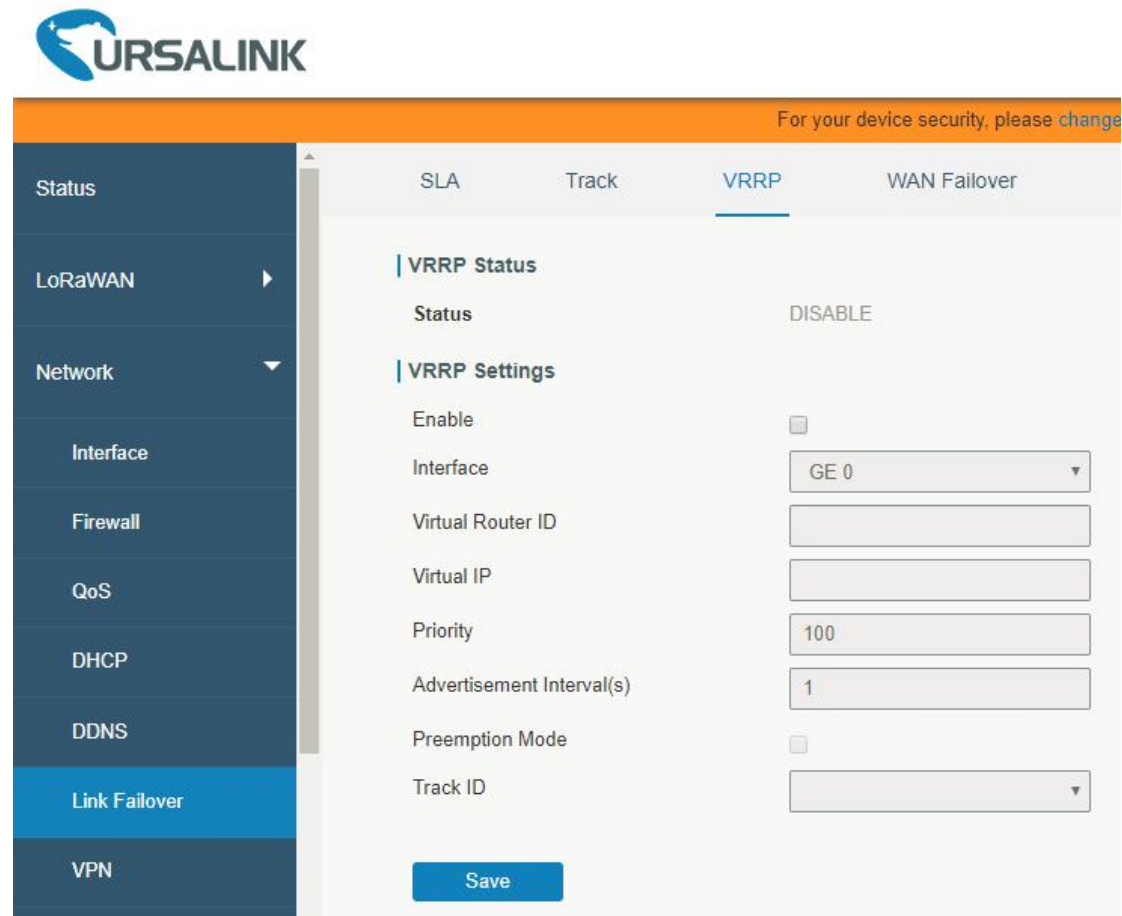

Figure 3-3-6-3

VRRP		
Item	Description	Default
Enable	Enable or disable VRRP.	Disable
Interface	Select the interface of Virtual Router.	None
Virtual Router ID	User-defined Virtual Router ID. Range: 1-255.	None
Virtual IP	Set the IP address of Virtual Router.	None
Priority	The VRRP priority range is 1-254 (a bigger number indicates a higher priority). The router with higher priority will be more likely to become the gateway router.	100
Advertisement Interval (s)	Heartbeat package transmission time interval between routers in the virtual ip group. Range: 1-255.	1
Preemption Mode	If the gateway works in the preemption mode, once it finds that its own priority is higher than that of the current gateway router, it will send VRRP notification package, resulting in re-election of gateway router and eventually replacing the original gateway router. Accordingly, the original gateway router will become a Backup router.	Disable
Track ID	Trace detection, select the defined track ID or blank	None

	character.	
--	------------	--

Table 3-3-6-3 VRRP Parameters

3.3.6.4 WAN Failover

WAN failover refers to failover between Ethernet WAN interface and cellular interface. When service transmission can't be carried out normally due to malfunction of a certain interface or lack of bandwidth, the rate of flow can be switched to backup interface quickly. Then the backup interface will carry out service transmission and share network flow so as to improve reliability of communication of data equipment.

When link state of main interface is switched from up to down, system will have the pre-set delay works instead of switching to link of backup interface immediately. Only if the state of main interface is still down after delay, will the system switch to link of backup interface. Otherwise, system will remain unchanged.

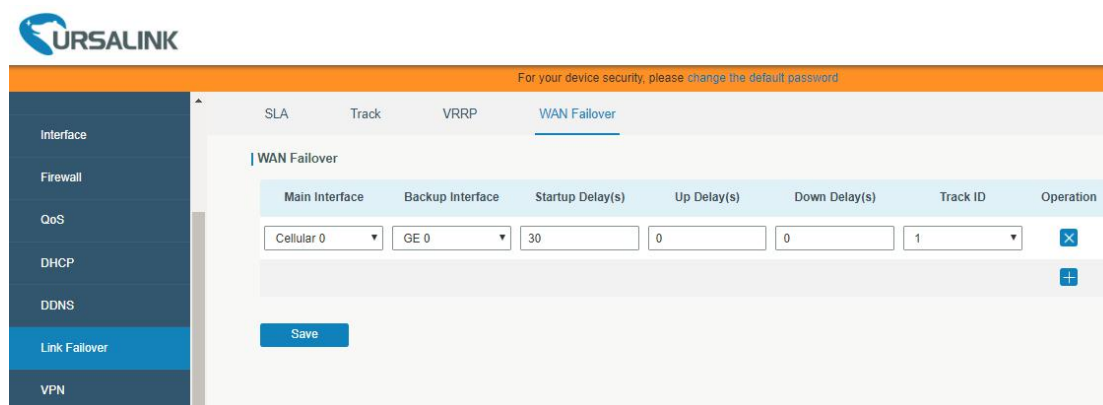

Figure 3-3-6-4

WAN Failover		
Parameters	Description	Default
Main Interface	Select a link interface as the main link.	Cellular0
Backup Interface	Select a link interface as the backup link.	GE0
Startup Delay (s)	Set how long to wait for the startup tracking detection policy to take effect. Range: 0-300.	3
Up Delay (s)	When the primary interface switches from failed detection to successful detection, switching can be delayed based on the set time. Range: 0-180 (0 refers to immediate switching).	0
Down Delay (s)	When the primary interface switches from successful detection to failed detection, switching can be delayed based on the set time. Range: 0-180 (0 refers to immediate switching).	0
Track ID	Track detection, select the defined track ID.	1

Table 3-3-6-4 WAN Failover Parameters

3.3.7 VPN

Virtual Private Networks, also called VPNs, are used to securely connect two private networks together so that devices can connect from one network to the other network via secure channels.

The UG87 supports DMVPN, IPsec, GRE, L2TP, PPTP, OpenVPN, as well as GRE over IPsec and L2TP over IPsec.

3.3.7.1 DMVPN

A dynamic multi-point virtual private network (DMVPN), combining mGRE and IPsec, is a secure network that exchanges data between sites without passing traffic through an organization's headquarter VPN server or gateway.



The screenshot displays the URSALINK web interface for configuring DMVPN. The navigation menu on the left includes Status, LoRaWAN, Network, Interface, Firewall, QoS, DHCP, DDNS, Link Failover, VPN (highlighted), System, Industrial, and Maintenance. The main content area has tabs for DMVPN, IPsec, GRE, L2TP, and PPTP. The DMVPN Settings section is active, showing the following configuration options:

Setting	Value
Enable	<input checked="" type="checkbox"/>
Hub Address	<input type="text"/>
Local IP Address	<input type="text"/>
GRE HUB IP Address	<input type="text"/>
GRE Local IP Address	<input type="text"/>
GRE Mask	255.255.255.0
GRE Key	<input type="text"/>
Negotiation Mode	Main
Authentication Algorithm	DES
Encryption Algorithm	MD5
DH Group	MODP768-1
Key	<input type="text"/>
Local ID Type	Default
IKE Life Time(s)	10800
SA Algorithm	DES-MD5
PFS Group	NULL
Life Time(s)	3600

Figure 3-3-7-1

VPN	DPD Time Interval(s)	<input type="text" value="30"/>
System	DPD Timeout(s)	<input type="text" value="150"/>
Industrial	Cisco Secret	<input type="text"/>
	NHRP Holdtime(s)	<input type="text" value="7200"/>

Figure 3-3-7-2

DMVPN	
Item	Description
Enable	Enable or disable DMVPN.
Hub Address	The IP address or domain name of DMVPN Hub.
Local IP address	DMVPN local tunnel IP address.
GRE Hub IP Address	GRE Hub tunnel IP address.
GRE Local IP Address	GRE local tunnel IP address.
GRE Netmask	GRE local tunnel netmask.
GRE Key	GRE tunnel key.
Negotiation Mode	Select from "Main" and "Aggressive".
Authentication Algorithm	Select from "DES", "3DES", "AES128", "AES192" and "AES256".
Encryption Algorithm	Select from "MD5" and "SHA1".
DH Group	Select from "MODP768_1", "MODP1024_2" and "MODP1536_5".
Key	Enter the preshared key.
Local ID Type	Select from "Default", "ID", "FQDN", and "User FQDN"
IKE Life Time (s)	Set the lifetime in IKE negotiation. Range: 60-86400.
SA Algorithm	Select from "DES_MD5", "DES_SHA1", "3DES_MD5", "3DES_SHA1", "AES128_MD5", "AES128_SHA1", "AES192_MD5", "AES192_SHA1", "AES256_MD5" and "AES256_SHA1".
PFS Group	Select from "NULL", "MODP768_1", "MODP1024_2" and "MODP1536-5".
Life Time (s)	Set the lifetime of IPsec SA. Range: 60-86400.
DPD Interval Time (s)	Set DPD interval time
DPD Timeout (s)	Set DPD timeout.
Cisco Secret	Cisco Nhrp key.
NHRP Holdtime (s)	The holdtime of Nhrp protocol.

Table 3-3-7-1 DMVPN Parameters

3.3.7.2 IPSec

IPsec is especially useful for implementing virtual private networks and for remote user access through dial-up connection to private networks. A big advantage of IPsec is that

security arrangements can be handled without requiring changes to individual user computers.

IPsec provides three choices of security service: Authentication Header (AH), Encapsulating Security Payload (ESP), and Internet Key Exchange (IKE). AH essentially allows authentication of the senders' data. ESP supports both authentication of the sender and data encryption. IKE is used for cipher code exchange. All of them can protect one and more data flows between hosts, between host and gateway, and between gateways.

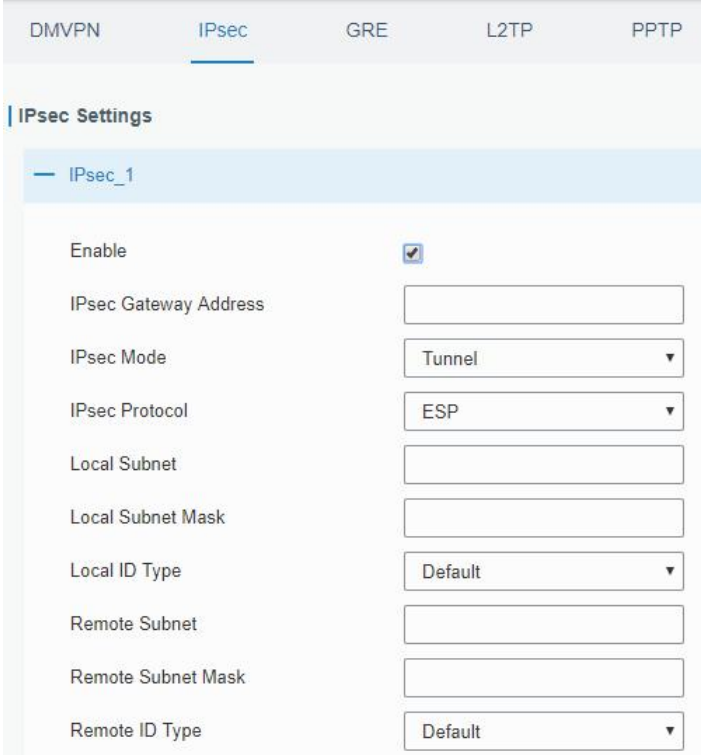

Figure 3-3-7-3

IPsec	
Item	Description
Enable	Enable IPsec tunnel. A maximum of 3 tunnels is allowed.
IPsec Gateway Address	Enter the IP address or domain name of remote IPsec server.
IPsec Mode	Select from "Tunnel" and "Transport".
IPsec Protocol	Select from "ESP" and "AH".
Local Subnet	Enter the local subnet IP address that IPsec protects.
Local Subnet Netmask	Enter the local netmask that IPsec protects.
Local ID Type	Select from "Default", "ID", "FQDN", and "User FQDN".
Remote Subnet	Enter the remote subnet IP address that IPsec protects.
Remote Subnet Mask	Enter the remote netmask that IPsec protects.
Remote ID type	Select from "Default", "ID", "FQDN", and "User FQDN".

Table 3-3-7-2 IPsec Parameters

IKE Parameter	<input checked="" type="checkbox"/>
IKE Version	IKEv1
Negotiation Mode	Main
Encryption Algorithm	DES
Authentication Algorithm	MD5
DH Group	MODP768-1
Local Authentication	PSK
Local Secrets	
XAUTH	<input type="checkbox"/>
Lifetime(s)	10800
SA Parameter	<input checked="" type="checkbox"/>
SA Algorithm	DES-MD5
PFS Group	NULL
Lifetime(s)	3600
DPD Time Interval(s)	30
DPD Timeout(s)	150
IPsec Advanced	<input checked="" type="checkbox"/>
Enable Compression	<input type="checkbox"/>
VPN Over IPsec Type	NONE

Figure 3-3-7-4

IKE Parameter	
Item	Description
IKE Version	Select from "IKEv1" and "IKEv2".
Negotiation Mode	Select from "Main" and "Aggressive".
Encryption Algorithm	Select from "DES", "3DES", "AES128", "AES192" and "AES256".
Authentication Algorithm	Select from "MD5" and "SHA1"
DH Group	Select from "MODP768_1", "MODP1024_2" and "MODP1536_5".
Local Authentication	Select from "PSK" and "CA".
Local Secrets	Enter the preshared key.
XAUTH	Enter XAUTH username and password after XAUTH is enabled.
Lifetime (s)	Set the lifetime in IKE negotiation. Range: 60-86400.
SA Parameter	
SA Algorithm	Select from "DES_MD5", "DES_SHA1", "3DES_MD5", "3DES_SHA1", "AES128_MD5", "AES128_SHA1", "AES192_MD5", "AES192_SHA1", "AES256_MD5" and "AES256_SHA1".
PFS Group	Select from "NULL", "MODP768_1", "MODP1024_2" and "MODP1536_5".
Lifetime (s)	Set the lifetime of IPsec SA. Range: 60-86400.

DPD Interval Time(s)	Set DPD interval time to detect if the remote side fails.
DPD Timeout(s)	Set DPD timeout. Range: 10-3600.
IPsec Advanced	
Enable Compression	The head of IP packet will be compressed after it's enabled.
VPN Over IPsec Type	Select from "NONE", "GRE" and "L2TP" to enable VPN over IPsec function.

Table 3-3-7-3 IPsec Parameters

3.3.7.3 GRE

Generic Routing Encapsulation (GRE) is a protocol that encapsulates packets in order to route other protocols over IP networks. It's a tunneling technology that provides a channel through which encapsulated data message can be transmitted and encapsulation and decapsulation can be realized at both ends.

In the following circumstances the GRE tunnel transmission can be applied:

- GRE tunnel can transmit multicast data packets as if it were a true network interface. Single use of IPsec cannot achieve the encryption of multicast.
- A certain protocol adopted cannot be routed.
- A network of different IP addresses shall be required to connect other two similar networks.

The screenshot displays the 'GRE Settings' configuration page. At the top, there are tabs for 'DMVPN', 'IPsec', 'GRE' (which is selected), 'L2TP', and 'PPTP'. Below the tabs, the 'GRE Settings' section is visible, containing a sub-section for 'GRE_1'. The configuration options include:

- Enable:** A checked checkbox.
- Remote IP Address:** An empty text input field.
- Local IP Address:** An empty text input field.
- Local Virtual IP Address:** An empty text input field.
- Netmask:** A text input field containing '255.255.255.0'.
- Peer Virtual IP Address:** An empty text input field.
- Global Traffic Forwarding:** An unchecked checkbox.
- Remote Subnet:** An empty text input field.
- Remote Netmask:** An empty text input field.
- MTU:** A text input field containing '1500'.
- Key:** An empty text input field.
- Enable NAT:** A checked checkbox.

Figure 3-3-7-5

GRE	
Item	Description
Enable	Check to enable GRE function.

Remote IP Address	Enter the real remote IP address of GRE tunnel.
Local IP Address	Set the local IP address.
Local Virtual IP Address	Set the local tunnel IP address of GRE tunnel.
Netmask	Set the local netmask.
Peer Virtual IP Address	Enter remote tunnel IP address of GRE tunnel.
Global Traffic Forwarding	All the data traffic will be sent out via GRE tunnel when this function is enabled.
Remote Subnet	Enter the remote subnet IP address of GRE tunnel.
Remote Netmask	Enter the remote netmask of GRE tunnel.
MTU	Enter the maximum transmission unit. Range: 64-1500.
Key	Set GRE tunnel key.
Enable NAT	Enable NAT traversal function.

Table 3-3-7-4 GRE Parameters

3.3.7.4 L2TP

Layer Two Tunneling Protocol (L2TP) is an extension of the Point-to-Point Tunneling Protocol (PPTP) used by an Internet service provider (ISP) to enable the operation of a virtual private network (VPN) over the Internet.

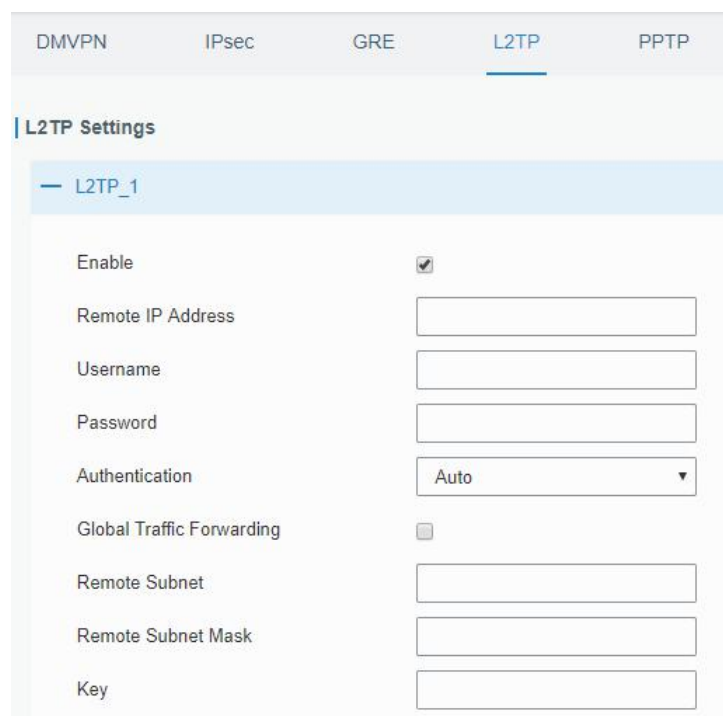

Figure 3-3-7-6

L2TP	
Item	Description
Enable	Check to enable L2TP function.
Remote IP Address	Enter the public IP address or domain name of L2TP server.
Username	Enter the username that L2TP server provides.
Password	Enter the password that L2TP server provides.
Authentication	Select from "Auto", "PAP", "CHAP", "MS-CHAPv1" and

	"MS-CHAPv2".
Global Traffic Forwarding	All of the data traffic will be sent out via L2TP tunnel after this function is enabled.
Remote Subnet	Enter the remote IP address that L2TP protects.
Remote Subnet Mask	Enter the remote netmask that L2TP protects.
Key	Enter the password of L2TP tunnel.

Table 3-3-7-5 L2TP Parameters

Advanced Settings	<input checked="" type="checkbox"/>
Local IP Address	<input type="text"/>
Peer IP Address	<input type="text"/>
Enable NAT	<input checked="" type="checkbox"/>
Enable MPPE	<input checked="" type="checkbox"/>
Address/Control Compression	<input type="checkbox"/>
Protocol Field Compression	<input type="checkbox"/>
Asyncmap Value	<input type="text" value="ffffff"/>
MRU	<input type="text" value="1500"/>
MTU	<input type="text" value="1500"/>
Link Detection Interval(s)	<input type="text" value="60"/>
Max Retries	<input type="text" value="0"/>
Expert Options	<input type="text"/>

Figure 3-3-7-7

Advanced Settings	
Item	Description
Local IP Address	Set tunnel IP address of L2TP client. Client will obtain tunnel IP address automatically from the server when it's null.
Peer IP Address	Enter tunnel IP address of L2TP server.
Enable NAT	Enable NAT traversal function.
Enable MPPE	Enable MPPE encryption.
Address/Control Compression	For PPP initialization. User can keep the default option.
Protocol Field Compression	For PPP initialization. User can keep the default option.
Asyncmap Value	One of the PPP protocol initialization strings. User can keep the default value. Range: 0-ffffff.
MRU	Set the maximum receive unit. Range: 64-1500.
MTU	Set the maximum transmission unit. Range: 64-1500
Link Detection Interval (s)	Set the link detection interval time to ensure tunnel connection. Range: 0-600.
Max Retries	Set the maximum times of retry to detect the L2TP connection

	failure. Range: 0-10.
Expert Options	User can enter some other PPP initialization strings in this field and separate the strings with blank space.

Table 3-3-7-6 L2TP Parameters

3.3.7.5 PPTP

Point-to-Point Tunneling Protocol (PPTP) is a protocol that allows corporations to extend their own corporate network through private "tunnels" over the public Internet. Effectively, a corporation uses a wide-area network as a single large local area network.

The screenshot shows the 'PPTP Settings' configuration page. At the top, there are tabs for 'DMVPN', 'IPsec', 'GRE', 'L2TP', and 'PPTP'. The 'PPTP' tab is selected. Below the tabs, there is a section titled 'PPTP Settings' with a sub-section 'PPTP_1'. The configuration options are as follows:

- Enable:** A checkbox that is checked.
- Remote IP Address:** A text input field.
- Username:** A text input field.
- Password:** A text input field.
- Authentication:** A dropdown menu with 'Auto' selected.
- Global Traffic Forwarding:** A checkbox that is unchecked.
- Remote Subnet:** A text input field.
- Remote Subnet Mask:** A text input field.

Figure 3-3-7-8

PPTP	
Item	Description
Enable	Enable PPTP client. A maximum of 3 tunnels is allowed.
Remote IP Address	Enter the public IP address or domain name of PPTP server.
Username	Enter the username that PPTP server provides.
Password	Enter the password that PPTP server provides.
Authentication	Select from "Auto", "PAP", "CHAP", "MS-CHAPv1", and "MS-CHAPv2".
Global Traffic Forwarding	All of the data traffic will be sent out via PPTP tunnel once enable this function.
Remote Subnet	Set the peer subnet of PPTP.
Remote Subnet Mask	Set the netmask of peer PPTP server.

Table 3-3-7-7 PPTP Parameters

Advanced Settings	<input checked="" type="checkbox"/>
Local IP Address	<input type="text"/>
Peer IP Address	<input type="text"/>
Enable NAT	<input checked="" type="checkbox"/>
Enable MPPE	<input checked="" type="checkbox"/>
Address/Control Compression	<input type="checkbox"/>
Protocol Field Compression	<input type="checkbox"/>
Asyncmap Value	<input type="text" value="ffffff"/>
MRU	<input type="text" value="1500"/>
MTU	<input type="text" value="1500"/>
Link Detection Interval(s)	<input type="text" value="60"/>
Max Retries	<input type="text" value="0"/>
Expert Options	<input type="text"/>

Figure 3-3-7-9

PPTP Advanced Settings	
Item	Description
Local IP Address	Set IP address of PPTP client.
Peer IP Address	Enter tunnel IP address of PPTP server.
Enable NAT	Enable the NAT function of PPTP.
Enable MPPE	Enable MPPE encryption.
Address/Control Compression	For PPP initialization. User can keep the default option.
Protocol Field Compression	For PPP initialization. User can keep the default option.
Asyncmap Value	One of the PPP protocol initialization strings. User can keep the default value. Range: 0-ffffff.
MRU	Enter the maximum receive unit. Range: 0-1500.
MTU	Enter the maximum transmission unit. Range: 0-1500.
Link Detection Interval (s)	Set the link detection interval time to ensure tunnel connection. Range: 0-600.
Max Retries	Set the maximum times of retrying to detect the PPTP connection failure. Range: 0-10.
Expert Options	User can enter some other PPP initialization strings in this field and separate the strings with blank space.

Table 3-3-7-8 PPTP Parameters

3.3.7.6 OpenVPN Client

OpenVPN is an open source virtual private network (VPN) product that offers a simplified security framework, modular network design, and cross-platform portability.

Advantages of OpenVPN include:

- Security provisions that function against both active and passive attacks.
- Compatibility with all major operating systems.
- High speed (1.4 megabytes per second typically).
- Ability to configure multiple servers to handle numerous connections simultaneously.
- All encryption and authentication features of the OpenSSL library.
- Advanced bandwidth management.
- A variety of tunneling options.
- Compatibility with smart cards that support the Windows Crypt application program interface (API).

The screenshot displays the 'OpenVPN Client Settings' interface. At the top, there are navigation tabs: DMVPN, IPsec, GRE, L2TP, PPTP, **OpenVPN Client**, OpenVPN Server, and Certificatio. Below the tabs, the 'OpenVPN Client Settings' section is visible, containing a sub-section for 'OpenVPN_1'. The settings are as follows:

- Enable:
- Protocol:
- Remote IP Address:
- Port:
- Interface:
- Authentication:
- Local Tunnel IP:
- Remote Tunnel IP:
- Enable NAT:
- Compression:
- Link Detection Interval(s):
- Link Detection Timeout(s):
- Cipher:
- MTU:
- Max Frame Size:
- Verbose Level:
- Expert Options:

At the bottom, there is a 'Local Route' section with a table structure:

Subnet	Subnet Mask	Operation
		+

Figure 3-3-7-10

OpenVPN Client	
Item	Description
Enable	Enable OpenVPN client. A maximum of 3 tunnels is allowed.

Protocol	Select from "UDP" and "TCP".
Remote IP Address	Enter remote OpenVPN server's IP address or domain name.
Port	Enter the listening port number of remote OpenVPN server. Range: 1-65535.
Interface	Select from "tun" and "tap".
Authentication	Select from "None", "Pre-shared", "Username/Password", "X.509 cert", and "X.509 cert+user".
Local Tunnel IP	Set local tunnel address.
Remote Tunnel IP	Enter remote tunnel address.
Global Traffic Forwarding	All the data traffic will be sent out via OpenVPN tunnel when this function is enabled.
Enable TLS Authentication	Check to enable TLS authentication.
Username	Enter username provided by OpenVPN server.
Password	Enter password provided by OpenVPN server.
Enable NAT	Enable NAT traversal function.
Compression	Select LZO to compress data.
Link Detection Interval (s)	Set link detection interval time to ensure tunnel connection. Range: 10-1800.
Link Detection Timeout (s)	Set link detection timeout. OpenVPN will be reestablished after timeout. Range: 60-3600.
Cipher	Select from "NONE", "BF-CBC", "DE-CBC", "DES-EDE3-CBC", "AES-128-CBC", "AES-192-CBC" and "AES-256-CBC".
MTU	Enter the maximum transmission unit. Range: 128-1500.
Max Frame Size	Set the maximum frame size. Range: 128-1500.
Verbose Level	Select from "ERROR", "WARNING", "NOTICE" and "DEBUG".
Expert Options	User can enter some other PPP initialization strings in this field and separate the strings with blank space.
Local Route	
Subnet	Set the local route's IP address.
Subnet Mask	Set the local route's netmask.

Table 3-3-7-9 OpenVPN Client Parameters

3.3.7.7 OpenVPN Server

The UG87 supports OpenVPN server to create secure point-to-point or site-to-site connections in routed or bridged configurations and remote access facilities.

DMVPN IPsec GRE L2TP PPTP OpenVPN Client **OpenVPN Server**

OpenVPN Server Settings

Enable

Protocol

Port

Listening IP

Interface

Authentication

Local Virtual IP

Remote Virtual IP

Enable NAT

Compression

Link Detection Interval

Cipher

MTU

Max Frame Size

Verbose Level

Expert Options

Figure 3-3-7-11

Local Route

Subnet	Netmask	Operation
		+

Account

Username	Password	Operation
		+

Figure 3-3-7-12

OpenVPN Server	
Item	Description
Enable	Enable/disable OpenVPN server.
Protocol	Select from TCP and UDP.
Port	Fill in listening port number. Range: 1-65535.
Listening IP	Enter WAN IP address or LAN IP address. Leaving it blank refers to all active WAN IP and LAN IP address.
Interface	Select from " tun" and "tap".
Authentication	Select from "None", "Pre-shared", "Username/Password", "X.509 cert" and "X. 509 cert +user".
Local Virtual IP	The local tunnel address of OpenVPN's tunnel.

Remote Virtual IP	The remote tunnel address of OpenVPN's tunnel.
Client Subnet	Local subnet IP address of OpenVPN client.
Client Netmask	Local netmask of OpenVPN client.
Renegotiation Interval(s)	Set interval for renegotiation. Range: 0-86400.
Max Clients	Maximum OpenVPN client number. Range: 1-128.
Enable CRL	Enable CRL
Enable Client to Client	Allow access between different OpenVPN clients.
Enable Dup Client	Allow multiple users to use the same certification.
Enable NAT	Check to enable the NAT traversal function.
Compression	Select "LZO" to compress data.
Link Detection Interval	Set link detection interval time to ensure tunnel connection. Range: 10-1800.
Cipher	Select from "NONE", "BF-CBC", "DES-CBC", "DES-EDE3-CBC", "AES-128-CBC", "AES-192-CBC" and "AES-256-CBC".
MTU	Enter the maximum transmission unit. Range: 64-1500.
Max Frame Size	Set the maximum frame size. Range: 64-1500.
Verbose Level	Select from "ERROR", "WARNING", "NOTICE" and "DEBUG".
Expert Options	User can enter some other PPP initialization strings in this field and separate the strings with blank space.
Local Route	
Subnet	The real local IP address of OpenVPN client.
Netmask	The real local netmask of OpenVPN client.
Account	
Username & Password	Set username and password for OpenVPN client.

Table 3-3-7-10 OpenVPN Server Parameters

3.3.7.8 Certifications

User can import/export certificate and key files for OpenVPN and IPsec on this page.

The screenshot shows the 'Certifications' tab in the configuration interface. Under the 'OpenVPN Client' section, there is a sub-section for 'OpenVPN client_1'. It contains a table of items for which certificates and keys can be managed:

Item	Description
CA	Import/Export CA certificate file.
Public Key	
Private Key	
TA	
Preshared Key	
PKCS12	

Figure 3-3-7-13

OpenVPN Client	
Item	Description
CA	Import/Export CA certificate file.

Public Key	Import/Export public key file.
Private Key	Import/Export private key file.
TA	Import/Export TA key file.
Preshared Key	Import/Export static key file.
PKCS12	Import/Export PKCS12 certificate file.

Table 3-3-7-11 OpenVPN Client Certification Parameters

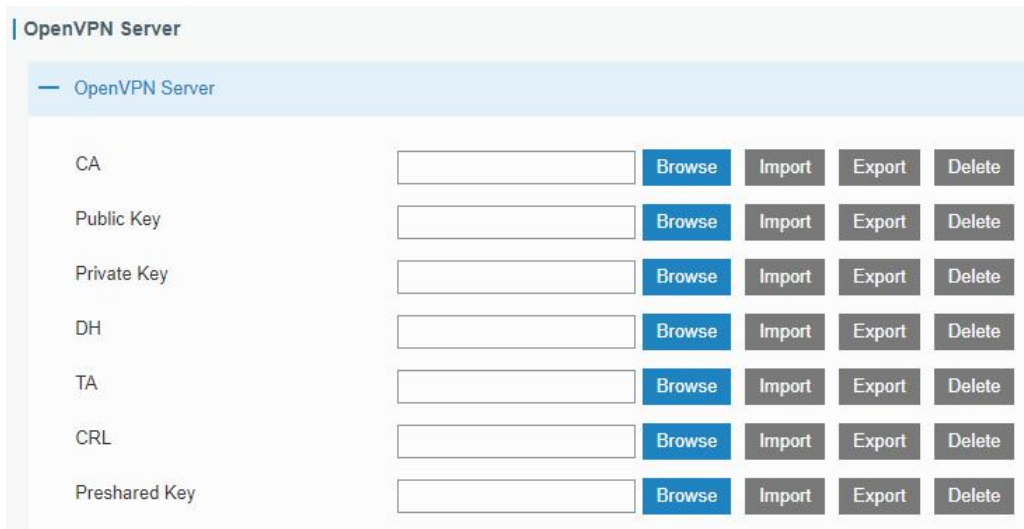

Figure 3-3-7-14

OpenVPN Server	
Item	Description
CA	Import/Export CA certificate file.
Public Key	Import/Export public key file.
Private Key	Import/Export private key file.
DH	Import/Export DH key file.
TA	Import/Export TA key file.
CRL	Import/Export CRL.
Preshared Key	Import/Export static key file.

Table 3-3-7-12 OpenVPN Server Parameters

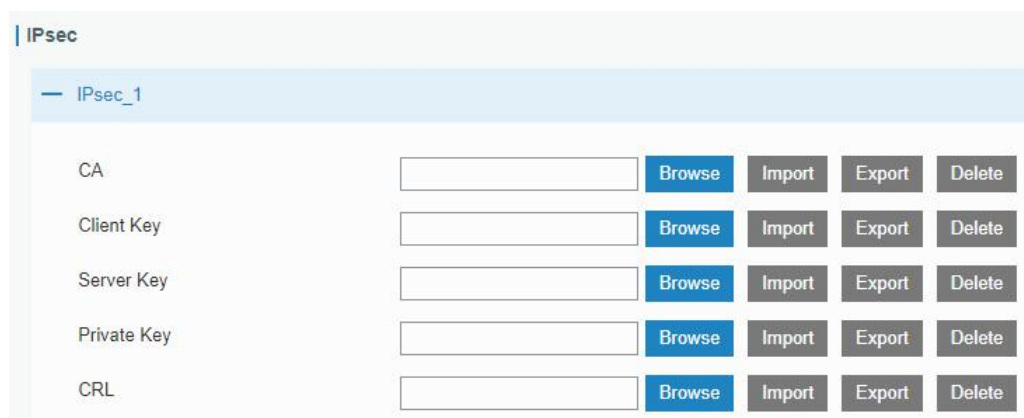

Figure 3-3-7-15

IPsec	
Item	Description
CA	Import/Export CA certificate.
Client Key	Import/Export client key.
Server Key	Import/Export server key.
Private Key	Import/Export private key.
CRL	Import/Export certificate recovery list.

Table 3-3-7-13 IPsec Parameters

3.4 System

This section describes how to configure general settings, such as administration account, access service, system time, common user management, SNMP, AAA, event alarms, etc.

3.4.1 General Settings

3.4.1.1 General

General settings include system info, access service and HTTPS certificates.

Enable	Service	Port
<input checked="" type="checkbox"/>	HTTP	80
<input checked="" type="checkbox"/>	HTTPS	443
<input type="checkbox"/>	TELNET	23
<input checked="" type="checkbox"/>	SSH	22

Figure 3-4-1-1

General		
Item	Description	Default
System		
Hostname	User-defined gateway name, needs to start with a letter.	URSA
Web Login Timeout (s)	You need to log in again if it times out. Range: 100-3600.	1800
Access Service		
Port	Set port number of the services. Range: 1-65535.	--

HTTP	Users can log in the device locally via HTTP to access and control it through Web after the option is checked.	80
HTTPS	Users can log in the device locally and remotely via HTTPS to access and control it through Web after option is checked.	8088
TELNET		8023
SSH	Users can log in the device locally and remotely via SSH after the option is checked.	8022
HTTPS Certificates		
Certificate	Click "Browse" button, choose certificate file on the PC, and then click "Import" button to upload the file into gateway. Click "Export" button will export the file to the PC. Click "Delete" button will delete the file.	--
Key	Click "Browse" button, choose key file on the PC, and then click "Import" button to upload the file into gateway. Click "Export" button will export file to the PC. Click "Delete" button will delete the file.	--

Table 3-4-1-1 General Setting Parameters

3.4.1.2 System Time

This section explains how to set the system time including time zone and time synchronization type.

Note: to ensure that the gateway runs with the correct time, it's recommended that you set the system time when configuring the gateway.

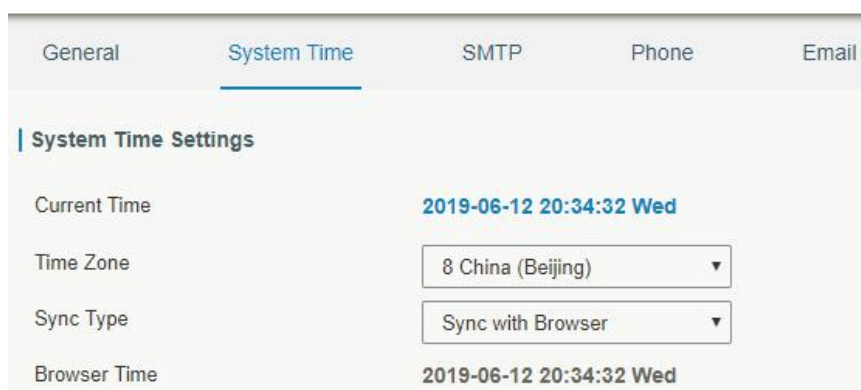

Figure 3-4-1-2

The screenshot shows the 'System Time' configuration page. At the top, there are tabs for 'General', 'System Time' (selected), 'SMTP', 'Phone', and 'Email'. Below the tabs is the 'System Time Settings' section. It includes the following fields:

- Current Time:** 2019-06-12 20:33:59 Wed
- Time Zone:** 8 China (Beijing) (dropdown menu)
- Sync Type:** Set up Manually (dropdown menu)
- Date:** 2019-06-12 (with a calendar icon)
- Time:** 20 (hours), 33 (minutes), 59 (seconds) (three separate dropdown menus)

Figure 3-4-1-3

The screenshot shows the 'System Time' configuration page with the 'Sync with NTP Server' option selected. It includes the following fields:

- Current Time:** 2019-06-12 20:33:36 Wed
- Time Zone:** 8 China (Beijing) (dropdown menu)
- Sync Type:** Sync with NTP Server (dropdown menu)
- NTP Server Address:** 1.cn.pool.ntp.org (text input field)
- Enable NTP Server:** (checkbox)

Figure 3-4-1-4

System Time	
Item	Description
Current Time	Show the current system time.
Time Zone	Click the drop down list to select the time zone you are in.
Sync Type	Click the drop down list to select the time synchronization type.
Sync with Browser	Synchronize time with browser.
Browser Time	Show the current time of browser.
Set up Manually	Manually configure the system time.
Sync with NTP Server	Synchronize time with NTP server so as to achieve time synchronization of all devices equipped with a clock on network.
Sync with NTP Server	
NTP Server Address	Set NTP server address (domain name/IP).
Enable NTP Server	NTP client on the network can achieve time synchronization with gateway after "Enable NTP Server" option is checked.

Table 3-4-1-2 System Time Parameters

3.4.1.3 SMTP

SMTP, short for Simple Mail Transfer Protocol, is a TCP/IP protocol used in sending and receiving e-mail. This section describes how to configure email settings.

Figure 3-4-1-5

SMTP	
Item	Description
SMTP Client Settings	
Enable	Enable or disable SMTP client function.
Email Address	Enter the sender's email account.
Password	Enter the sender's email password.
SMTP Server Address	Enter SMTP server's domain name.
Port	Enter SMTP server port. Range: 1-65535.
Enable TLS	Enable or disable TLS encryption.

Table 3-4-1-3 SMTP Setting

Related Topics

[Events Setting](#)

3.4.1.4 Phone

Phone settings involve in call/SMS trigger and SMS alarm for events.

1. Add phone list.
2. Select phone numbers and add them to the phone group.
3. Go to “Network > Interface > Cellular > Connection Mode > Connect on Demand > Trigger by Call / Trigger by SMS” or go to “System > Events > Event Settings > SMS” and then select the phone group ID.

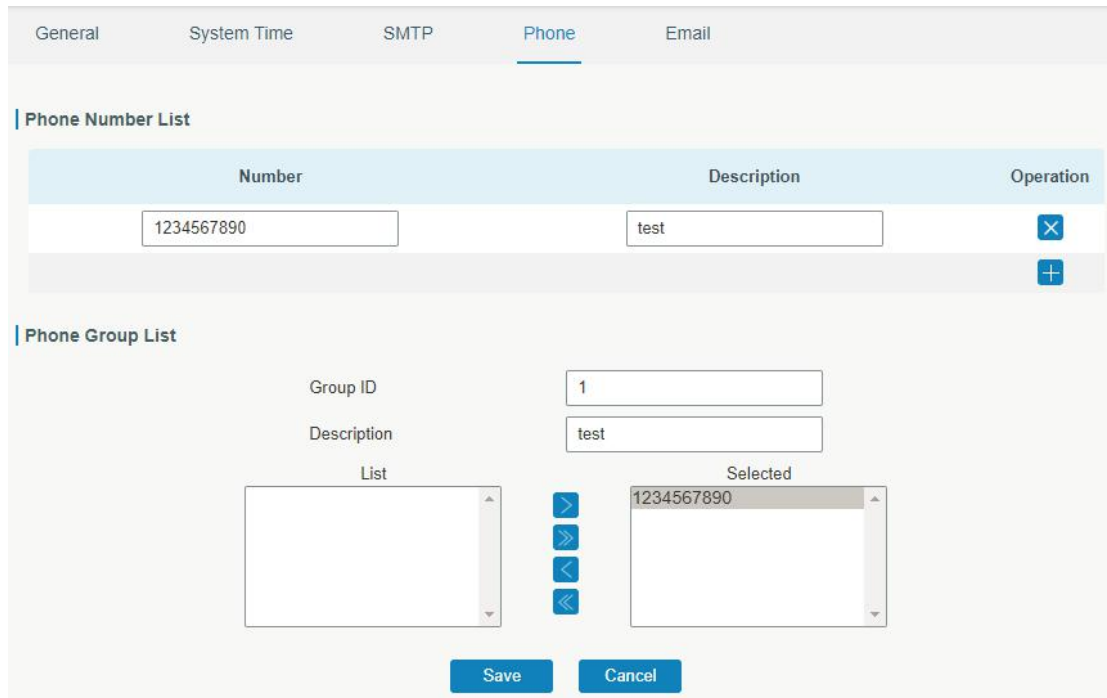

Figure 3-4-1-6

Phone	
Item	Description
Phone Number List	
Number	Enter the telephone number. Digits, "+" and "-" are allowed.
Description	The description of the telephone number.
Phone Group List	
Group ID	Set number for phone group. Range: 1-100.
Description	The description of the phone group.
List	Show the phone list.
Selected	Show the selected phone number.

Table 3-4-1-4 Phone Settings

Related Topic

[Connect on Demand](#)

3.4.1.5 Email

Email settings involve email alarm for events.

1. Add email list.
2. Select email addresses and add them to the phone group.
3. Go to "System > Events > Event Settings > Email" and then select the email group ID.

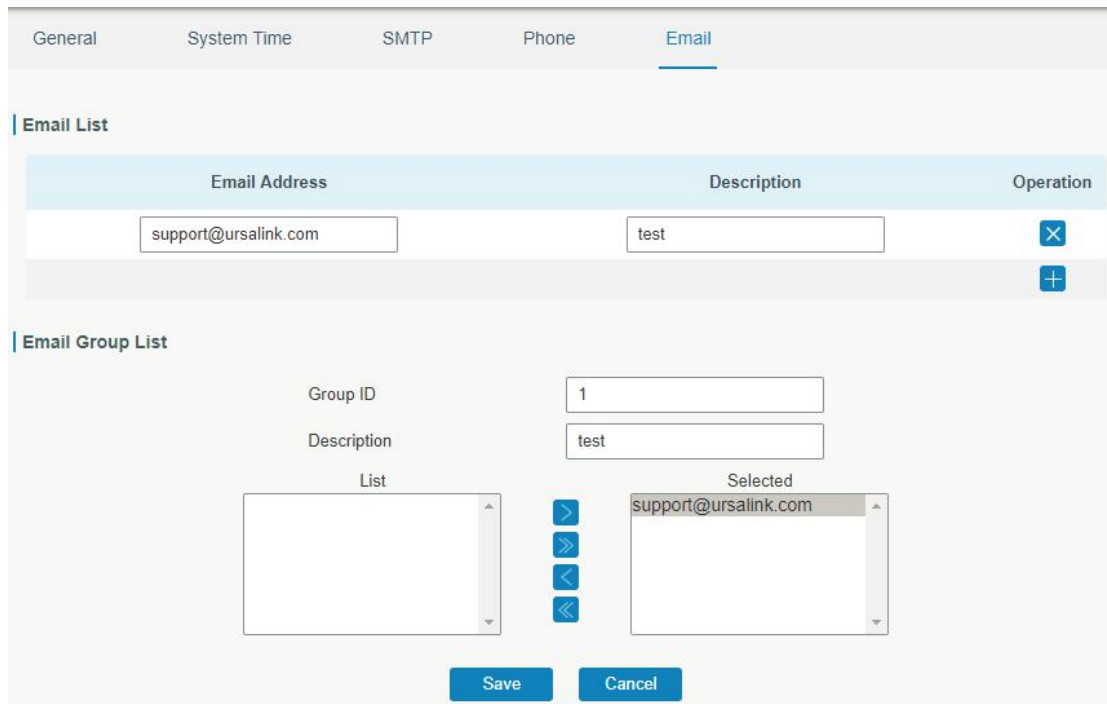

Figure 3-4-1-7

Email	
Item	Description
Email List	
Email Address	Enter the Email address.
Description	The description of the Email address.
Email Group List	
Group ID	Set number for email group. Range: 1-100.
Description	The description of the Email group.
List	Show the Email address list.
Selected	Show the selected Email address.

Table 3-4-1-5 Email Settings

3.4.2 User Management

3.4.2.1 Account

Here you can change the login username and password of the administrator.

Note: it is strongly recommended that you modify them for the sake of security.

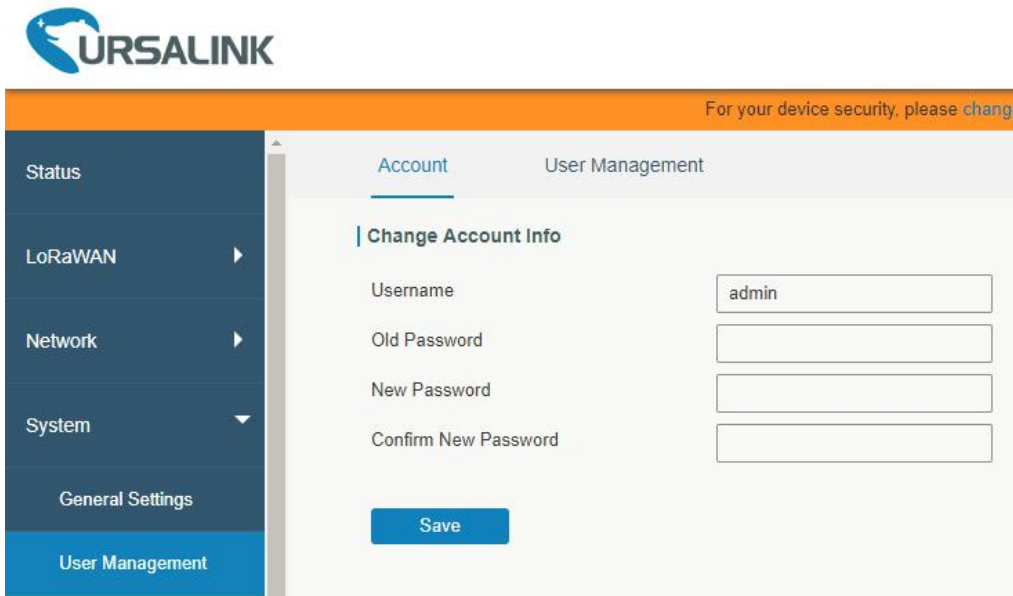

Figure 3-4-2-1

Account	
Item	Description
Username	Enter a new username. You can use characters such as a-z, 0-9, "_", "-", "\$". The first character can't be a digit.
Old Password	Enter the old password.
New Password	Enter a new password.
Confirm New Password	Enter the new password again.

Table 3-4-2-1 Account Information

3.4.2.2 User Management

This section describes how to create common user accounts.

The common user permission includes Read-Only and Read-Write.

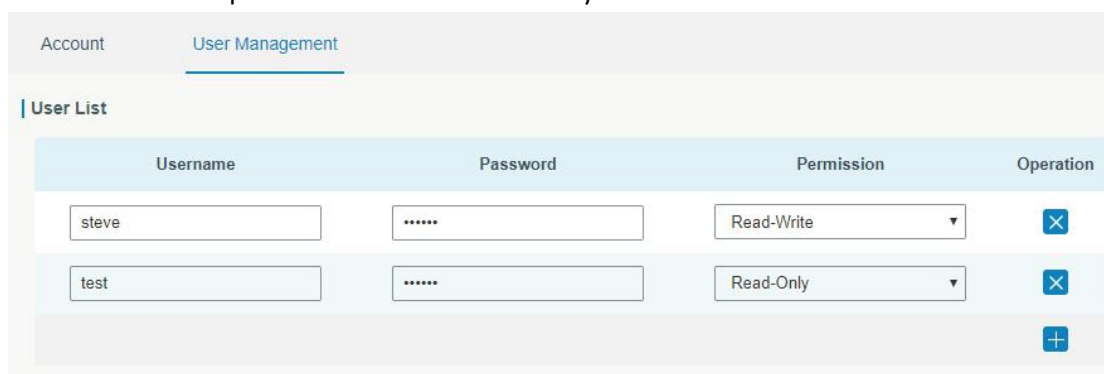

Figure 3-4-2-2

User Management	
Item	Description
Username	Enter a new username. You can use characters such as a-z, 0-9, "_", "-", "\$". The first character can't be a digit.
Password	Set password.
Permission	Select user permission from "Read-Only" and "Read-Write".

	<ul style="list-style-type: none"> - Read-Only: users can only view the configuration of gateway in this level. - Read-Write: users can view and set the configuration of gateway in this level.
--	--

Table 3-4-2-2 User Management

3.4.3 SNMP

SNMP is widely used in network management for network monitoring. SNMP exposes management data with variables form in managed system. The system is organized in a management information base (MIB) which describes the system status and configuration. These variables can be remotely queried by managing applications.

Configuring SNMP in networking, NMS, and a management program of SNMP should be set up at the Manager.

Configuration steps are listed as below for achieving query from NMS:

1. Enable SNMP setting.
2. Download MIB file and load it into NMS.
3. Configure MIB View.
4. Configure VCAM.

3.4.3.1 SNMP

The UG87 supports SNMPv1, SNMPv2c and SNMPv3 version. SNMPv1 and SNMPv2c employ community name authentication. SNMPv3 employs authentication encryption by username and password.

Figure 3-4-3-1

SNMP Settings	
Item	Description
Enable	Enable or disable SNMP function.
Port	Set SNMP listened port. Range: 1-65535. The default port is 161.
SNMP Version	Select SNMP version; support SNMP v1/v2c/v3.

Location Information	Fill in the location information.
Contact Information	Fill in the contact information.

Table 3-4-3-1 SNMP Parameters

3.4.3.2 MIB View

This section explains how to configure MIB view for the objects.

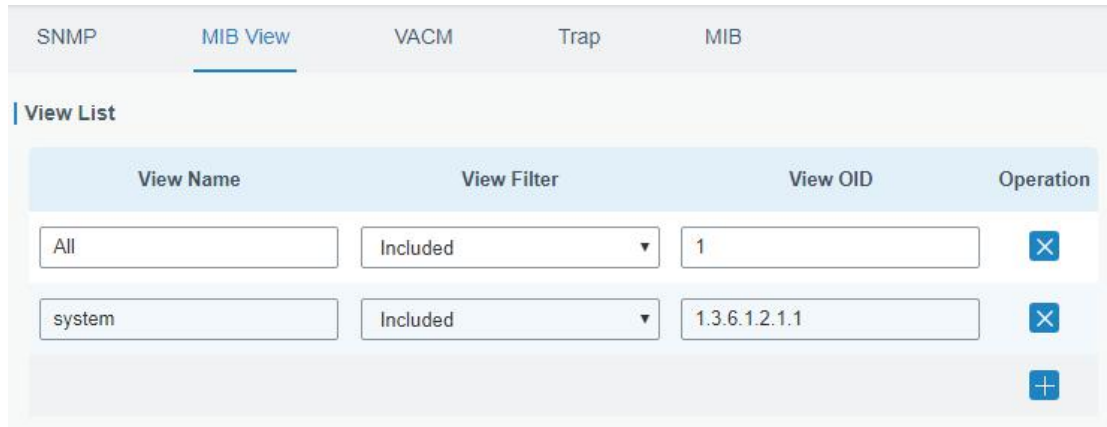

Figure 3-4-3-2

MIB View	
Item	Description
View Name	Set MIB view's name.
View Filter	Select from "Included" and "Excluded".
View OID	Enter the OID number.
Included	You can query all nodes within the specified MIB node.
Excluded	You can query all nodes except for the specified MIB node.

Table 3-3-3-2 MIB View Parameters

3.4.3.3 VACM

This section describes how to configure VCAM parameters.

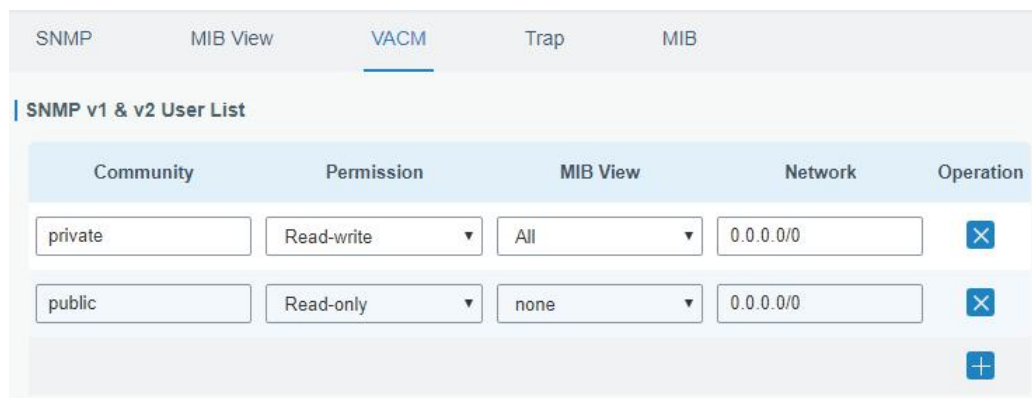

Figure 3-4-3-3

VACM	
Item	Description
SNMP v1 & v2 User List	
Community	Set the community name.
Permission	Select from "Read-Only" and "Read-Write".
MIB View	Select an MIB view to set permissions from the MIB view list.
Network	The IP address and bits of the external network accessing the MIB view.
Read-Write	The permission of the specified MIB node is read and write.
Read-Only	The permission of the specified MIB node is read only.
SNMP v3 User List	
Group Name	Set the name of SNMPv3 group.
Security Level	Select from "NoAuth/NoPriv", "Auth/NoPriv", and "Auth/Priv".
Read-Only View	Select an MIB view to set permission as "Read-only" from the MIB view list.
Read-Write View	Select an MIB view to set permission as "Read-write" from the MIB view list.
Inform View	Select an MIB view to set permission as "Inform" from the MIB view list.

Table 3-4-3-3 VACM Parameters

3.4.3.4 Trap

This section explains how to enable network monitoring by SNMP trap.

Figure 3-4-3-4

SNMP Trap	
Item	Description
Enable	Enable or disable SNMP Trap function.
SNMP Version	Select SNMP version; support SNMP v1/v2c/v3.
Server Address	Fill in NMS's IP address or domain name.
Port	Fill in UDP port. Port range is 1-65535. The default port is 162.
Name	Fill in the group name when using SNMP v1/v2c; fill in the username when using SNMP v3.
Auth/Priv Mode	Select from "NoAuth & No Priv", "Auth & NoPriv", and "Auth & Priv".

Table 3-4-3-4 Trap Parameters

3.4.3.5 MIB

This section describes how to download MIB files. The last MIB file “URSA-gateway-MIB.txt” is for the UG87.

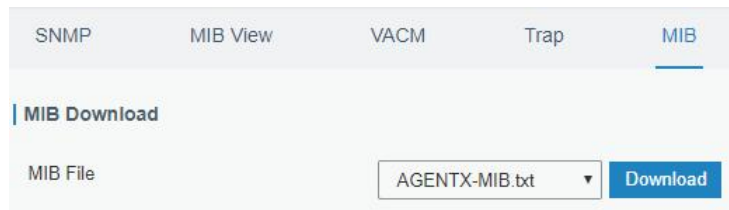

Figure 3-4-3-5

MIB	
Item	Description
MIB File	Select the MIB file you need.
Download	Click "Download" button to download the MIB file to PC.

Table 3-4-3-5 MIB Download

3.4.4 AAA

AAA access control is used for visitors control and the available corresponding services once access is allowed. It adopts the same method to configure three independent safety functions. It provides modularization methods for following services:

- Authentication: verify if the user is qualified to access to the network.
- Authorization: authorize related services available for the user.
- Charging: record the utilization of network resources.

3.4.4.1 RADIUS

Using UDP for its transport, RADIUS is generally applied in various network environments with higher requirements of security and permission of remote user access.

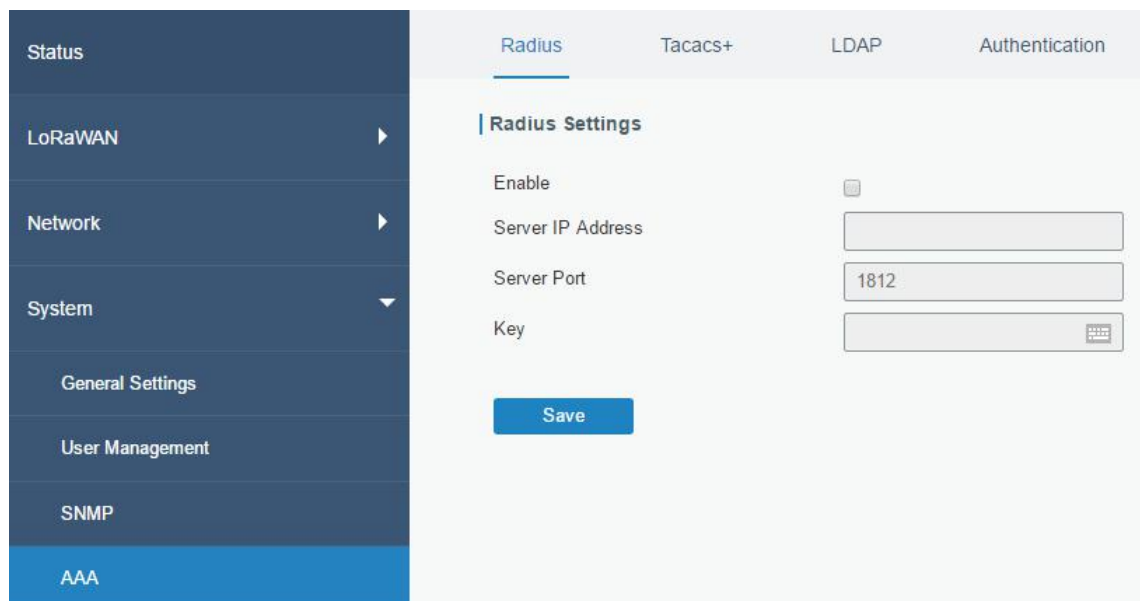

Figure 3-4-4-1

RADIUS	
Item	Description
Enable	Enable or disable RADIUS.
Server IP Address	Fill in the RADIUS server IP address/domain name.
Server Port	Fill in the RADIUS server port. Range: 1-65535.
Key	Fill in the key consistent with that of RADIUS server in order to get connected with RADIUS server.

Table 3-4-4-1 RADIUS Parameters

3.4.4.2 TACACS+

Using TCP for its transport, TACACS+ is mainly used for authentication, authorization and charging of the access users and terminal users by adopting PPP and VPDN.

Figure 3-4-4-2

TACACS+	
Item	Description
Enable	Enable or disable TACACS+.
Server IP Address	Fill in the TACACS+ server IP address/domain name.
Server Port	Fill in the TACACS+ server port. Range: 1-65535.
Key	Fill in the key consistent with that of TACACS+ server in order to get connected with TACACS+ server.

Table 3-4-4-2 TACACS+ Parameters

3.4.4.3 LDAP

A common usage of LDAP is to provide a central place to store usernames and passwords. This allows many different applications and services to connect the LDAP server to validate users.

LDAP is based on a simpler subset of the standards contained within the X.500 standard. Because of this relationship, LDAP is sometimes called X.500-lite as well.

The screenshot shows the LDAP Settings configuration interface. It includes a navigation bar with tabs for Radius, Tacacs+, LDAP (active), and Authentication. Below the tabs, the 'LDAP Settings' section contains the following fields:

- Enable:** A checkbox that is checked.
- Server IP Address:** An empty text input field.
- Server Port:** A text input field containing the value '389'.
- Base DN:** An empty text input field.
- Security:** A dropdown menu currently set to 'None'.
- Username:** An empty text input field.
- Password:** An empty text input field.

Figure 3-4-4-3

LDAP	
Item	Description
Enable	Enable or Disable LDAP.
Server IP Address	Fill in the LDAP server's IP address/domain name. The maximum count is 10.
Server Port	Fill in the LDAP server's port. Range: 1-65535
Base DN	The top of LDAP directory tree.
Security	Select secure method from "None", "StartTLS" and "SSL".
Username	Enter the username to access the server.
Password	Enter the password to access the server.

Table 3-4-4-3 LDAP Parameters

3.4.4.4 Authentication

AAA supports the following authentication ways:

- None: uses no authentication, generally not recommended.
- Local: uses the local username database for authentication.
 - Advantages: rapidness, cost reduction.
 - Disadvantages: storage capacity limited by hardware.
- Remote: has user's information stored on authentication server. RADIUS, TACACS+ and LDAP supported for remote authentication.

When RADIUS, TACACS+, and local are configured at the same time, the priority level is: 1 > 2 > 3.

Service	1	2	3
Console	None	None	None
Web	None	None	None
Telnet	None	None	None
SSH	None	None	None

Figure 3-4-4-4

Authentication	
Item	Description
Console	Select authentication for Console access.
Web	Select authentication for Web access.
Telnet	Select authentication for Telnet access.
SSH	Select authentication for SSH access.

Table 3-4-4-4 Authentication Parameters

3.4.5 Device Management

You can connect the device to the DeviceHub on this page so as to manage the gateway centrally and remotely.

Figure 3-4-5-1

DeviceHub	
Item	Description
Status	Show the connection status between the gateway and the

	DeviceHub.
Disconnected	Click this button to disconnect the gateway from the DeviceHub.
Activation Server Address	IP address or domain of the DeviceHub.
DeviceHub Server Address	The URL address for the device to connect to the DeviceHub, e.g. http://220.82.63.79:8080/acs.
Activation Method	Select activation method to connect the gateway to the DeviceHub server, options are "By Authentication ID" and "By ID".
Authentication Code	Fill in the authentication code generated from the DeviceHub.
ID	Fill in the registered DeviceHub account (email) and password.
Password	

Table 3-4-5-1

3.4.6 Events

Event feature is capable of sending alerts by Email when certain system events occur.

3.4.6.1 Events

You can view alarm messages on this page.

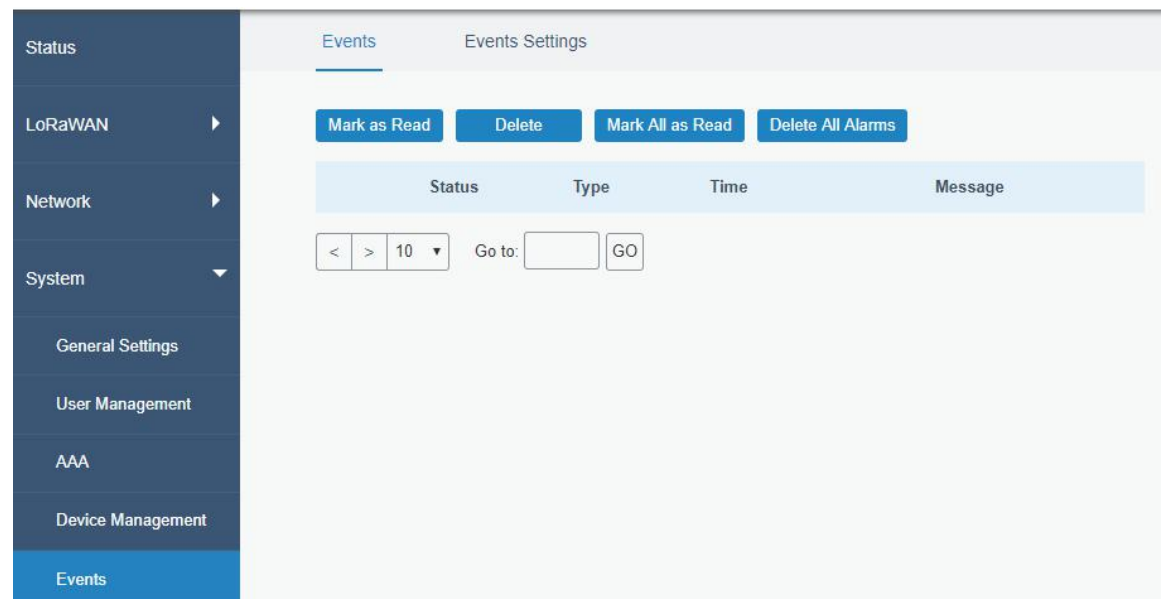

Figure 3-4-6-1

Events	
Item	Description
Mark as Read	Mark the selected event alarm as read.
Delete	Delete the selected event alarm.
Mark All as Read	Mark all event alarms as read.
Delete All Alarms	Delete all event alarms.
Status	Show the reading status of the event alarms, such as "Read" and

	“Unread”.
Type	Show the event type that should be alarmed.
Time	Show the alarm time.
Message	Show the alarm content.

Table 3-4-6-1 Events Parameters

3.4.6.2 Events Settings

In this section, you can decide what events to record and whether you want to receive email and SMS notifications when any change occurs.

Events	Record	Email Email Setting	SMS SMS Setting
Cellular Up	<input type="checkbox"/>	<input type="checkbox"/>	<input type="checkbox"/>
Cellular Down	<input type="checkbox"/>	<input type="checkbox"/>	<input type="checkbox"/>
WAN Up	<input type="checkbox"/>	<input type="checkbox"/>	<input type="checkbox"/>
WAN Down	<input type="checkbox"/>	<input type="checkbox"/>	<input type="checkbox"/>
VPN Up	<input type="checkbox"/>	<input type="checkbox"/>	<input type="checkbox"/>
VPN Down	<input type="checkbox"/>	<input type="checkbox"/>	<input type="checkbox"/>

Figure 3-4-6-2

Event Settings	
Item	Description
Enable	Check to enable "Events Settings".
Cellular Up	Cellular network is connected.
Cellular Down	Cellular network is disconnected.
WAN Up	Ethernet cable is connected to WAN port.
WAN Down	Ethernet cable is disconnected to WAN port.
VPN Up	VPN is connected.
VPN Down	VPN is disconnected.
Record	The relevant content of event alarm will be recorded on "Event" page if this option is checked.
Email	The relevant content of event alarm will be sent out via email if this

	option is checked.
Email Setting	Click and you will be redirected to the page "Email" to configure the Email group.
SMS	The relevant content of event alarm will be sent out via SMS if this option is checked.
SMS Setting	Click and you will be redirected to the page of "Phone" to configure phone group list.
Phone Group List	Select phone group to receive SMS alarm.
Email Group List	Select Email group to receive Email alarm.

Table 3-4-6-2 Events Parameters

Related Topics

[Email Setting](#)

[Phone Setting](#)

3.5 Maintenance

This section describes system maintenance tools and management.

3.5.1 Tools

Troubleshooting tools includes ping and traceroute.

3.5.1.1 Ping

Ping tool is engineered to ping outer network.

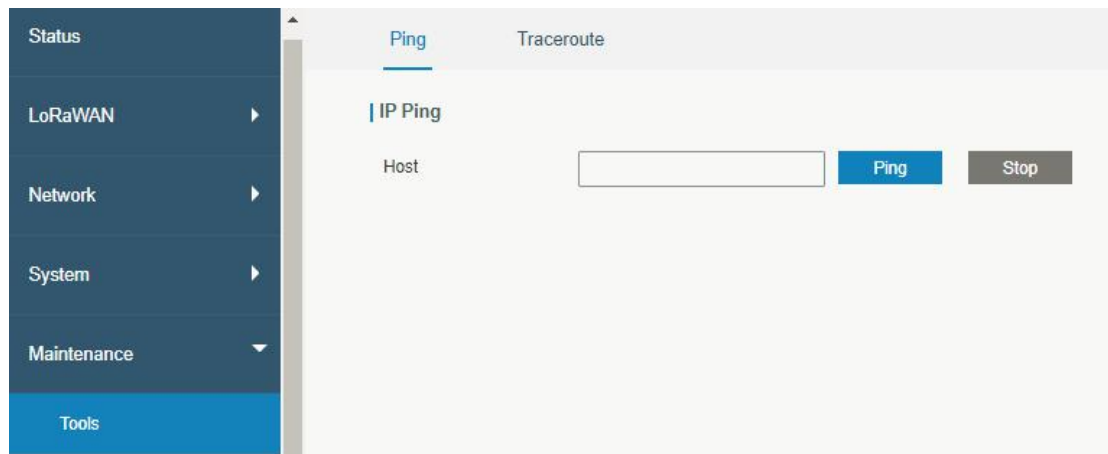

Figure 3-5-1-1

PING	
Item	Description
Host	Ping outer network from the gateway.

Table 3-5-1-1 IP Ping Parameters

3.5.1.2 Traceroute

Traceroute tool is used for troubleshooting network routing failures.

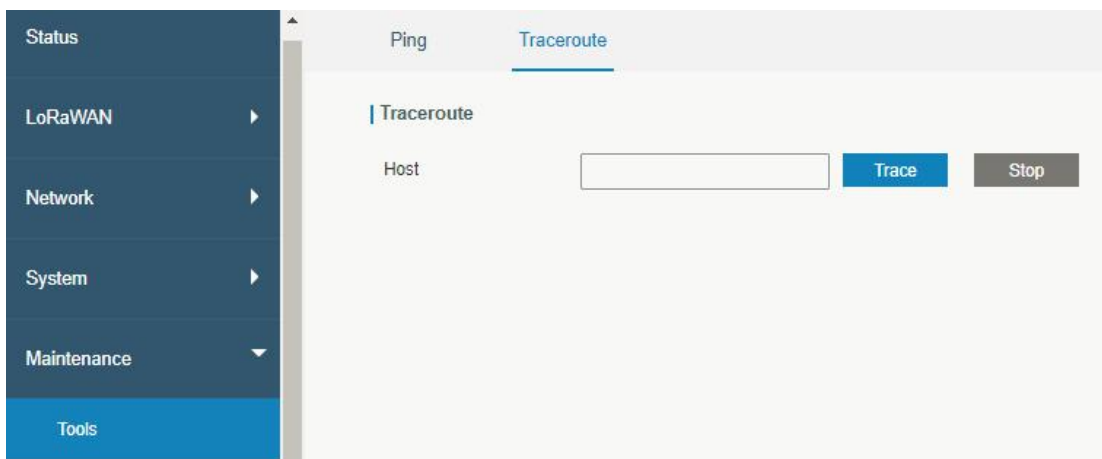

Figure 3-5-1-2

Traceroute	
Item	Description
Host	Address of the destination host to be detected.

Table 3-5-1-2 Traceroute Parameters

3.5.2 Schedule

This section explains how to configure scheduled reboot on the gateway.

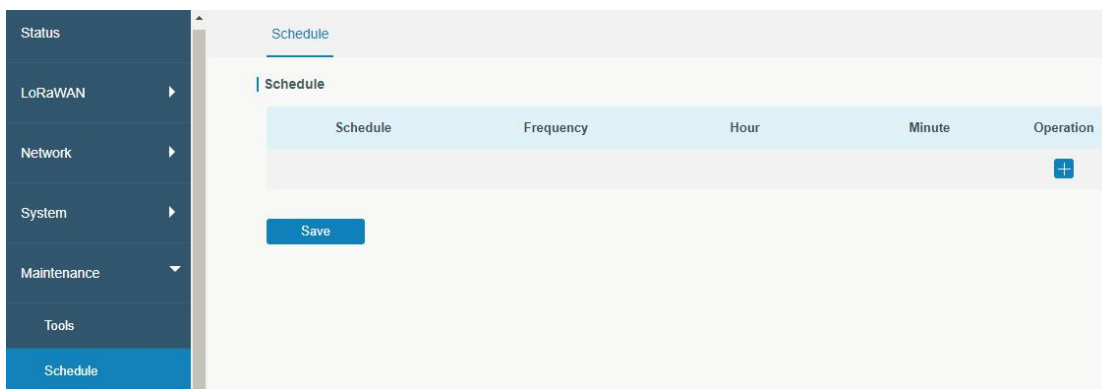

Figure 3-5-2-1

Schedule	
Item	Description
Schedule	Select schedule type.
Reboot	Reboot the gateway regularly.
Frequency	Select the frequency to execute the schedule.
Hour & Minute	Select the time to execute the schedule.

Table 3-5-2-1 Schedule Parameters

3.5.3 Log

The system log contains a record of informational, error and warning events that indicates how the system processes. By reviewing the data contained in the log, an administrator or user troubleshooting the system can identify the cause of a problem or whether the system processes are loading successfully. Remote log server is feasible, and gateway will upload all

system logs to remote log server such as Syslog Watcher.

3.5.3.1 System Log

This section describes how to download log file and view the recent log on web.

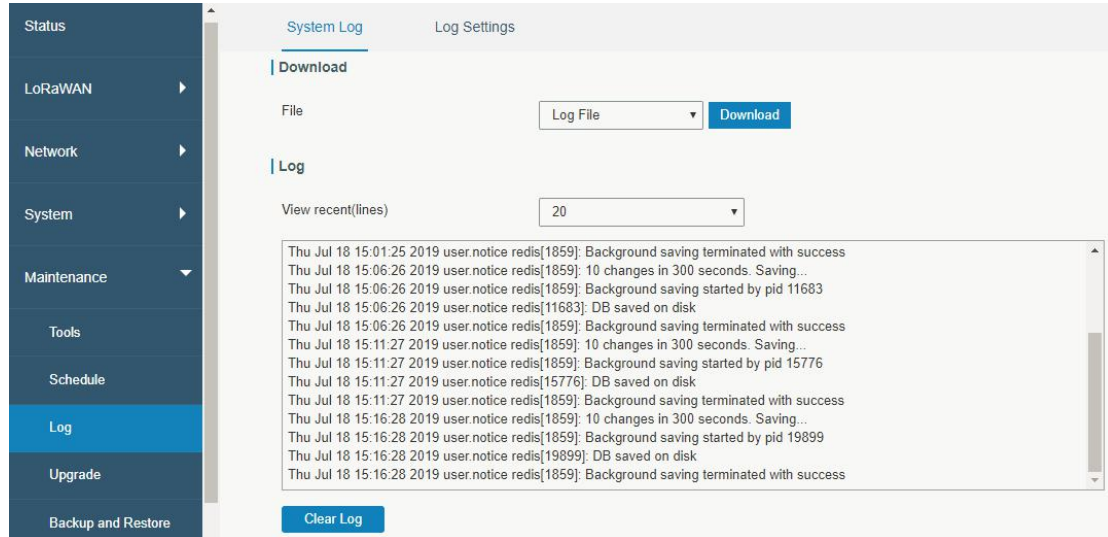

Figure 3-5-3-1

System Log	
Item	Description
Download	Download log file.
View recent (lines)	View the specified lines of system log.
Clear Log	Clear the current system log.

Table 3-5-3-1 System Log Parameters

3.5.3.2 Log Settings

This section explains how to enable remote log server and local log setting.

Figure 3-5-3-2

Log Settings	
Item	Description
Remote Log Server	
Enable	With “Remote Log Server” enabled, gateway will send all system logs to the remote server.
Syslog Server Address	Fill in the remote system log server address (IP/domain name).
Port	Fill in the remote system log server port.
Local Log File	
Storage	User can store the log file in memory or TF card.
Size	Set the size of the log file to be stored.
Log Severity	The list of severities follows the syslog protocol.

Table 3-5-3-2 System Log Parameters

3.5.4 Upgrade

This section describes how to upgrade the gateway firmware via web. Generally you don't need to do the firmware upgrade.

Note: any operation on web page is not allowed during firmware upgrade, otherwise the upgrade will be interrupted, or even the device will break down.

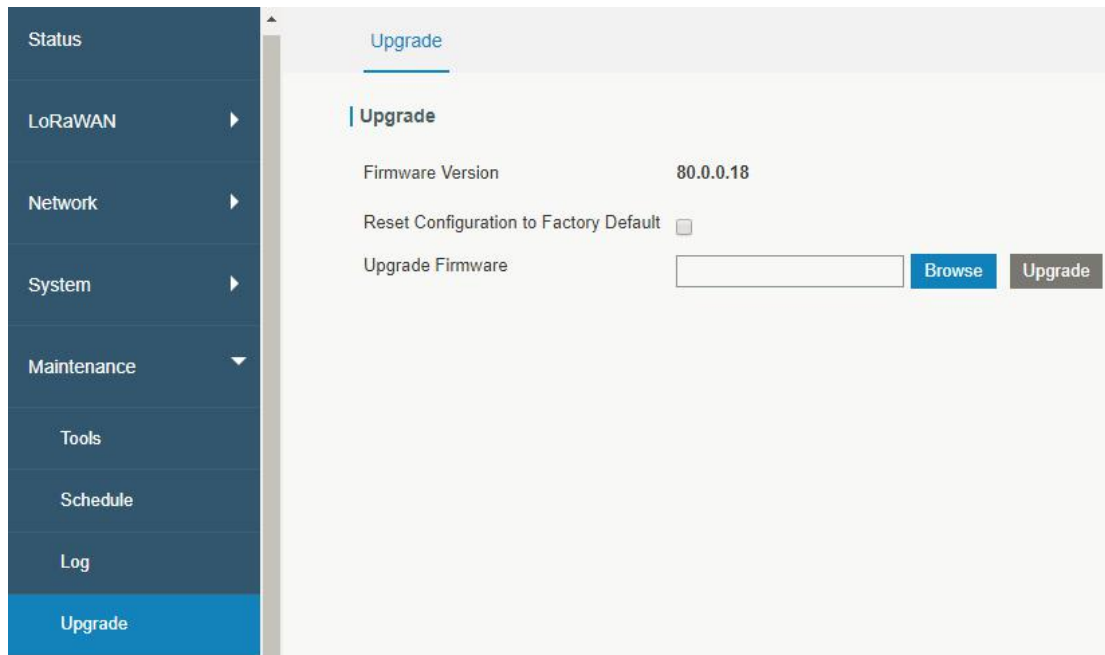

Figure 3-5-4-1

Upgrade	
Item	Description
Firmware Version	Show the current firmware version.
Reset Configuration to Factory Default	When this option is checked, the gateway will be reset to factory defaults after upgrade.
Upgrade Firmware	Click "Browse" button to select the new firmware file, and click "Upgrade" to upgrade firmware.

Table 3-5-4-1 Upgrade Parameters

Related Configuration Example

[Firmware Upgrade](#)

3.5.5 Backup and Restore

This section explains how to create a complete backup of the system configurations to a file, restore the config file to the gateway and reset to factory defaults.

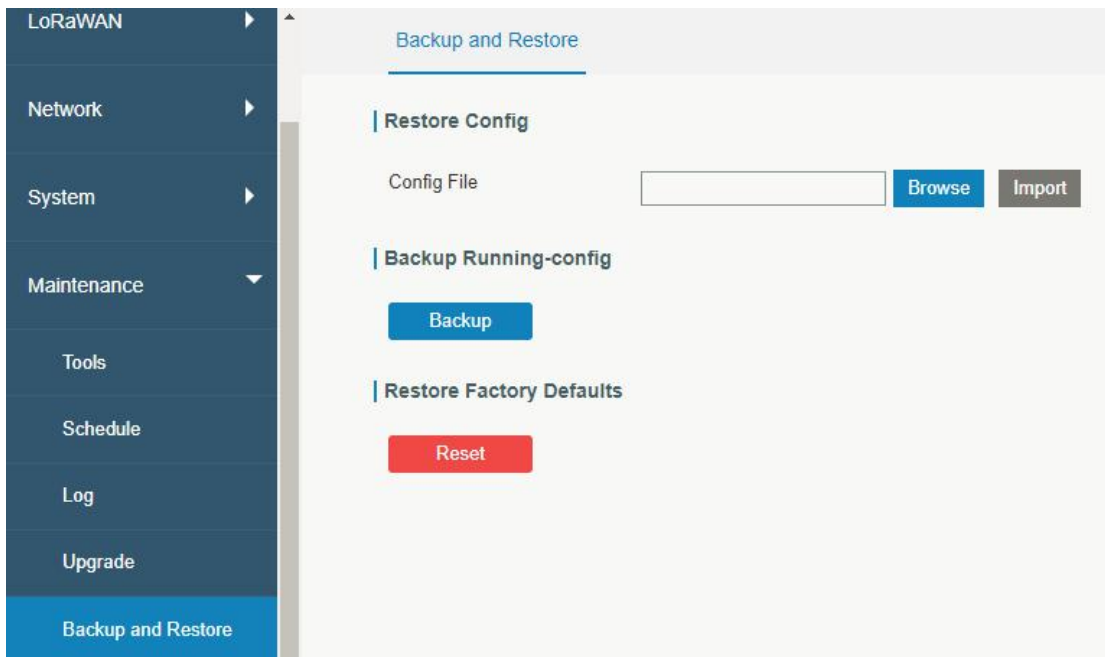

Figure 3-5-5-1

Backup and Restore	
Item	Description
Config File	Click "Browse" button to select configuration file, and then click "Import" button to upload the configuration file to the gateway.
Backup	Click "Backup" to export the current configuration file to the PC.
Reset	Click "Reset" button to reset factory default settings. gateway will restart after reset process is done.

Table 3-5-5-1 Backup and Restore Parameters

Related Configuration Example

[Restore Factory Defaults](#)

3.5.6 Reboot

On this page you can reboot the gateway and return to the login page. We strongly recommend clicking “Save” button before rebooting the gateway so as to avoid losing the new configuration.

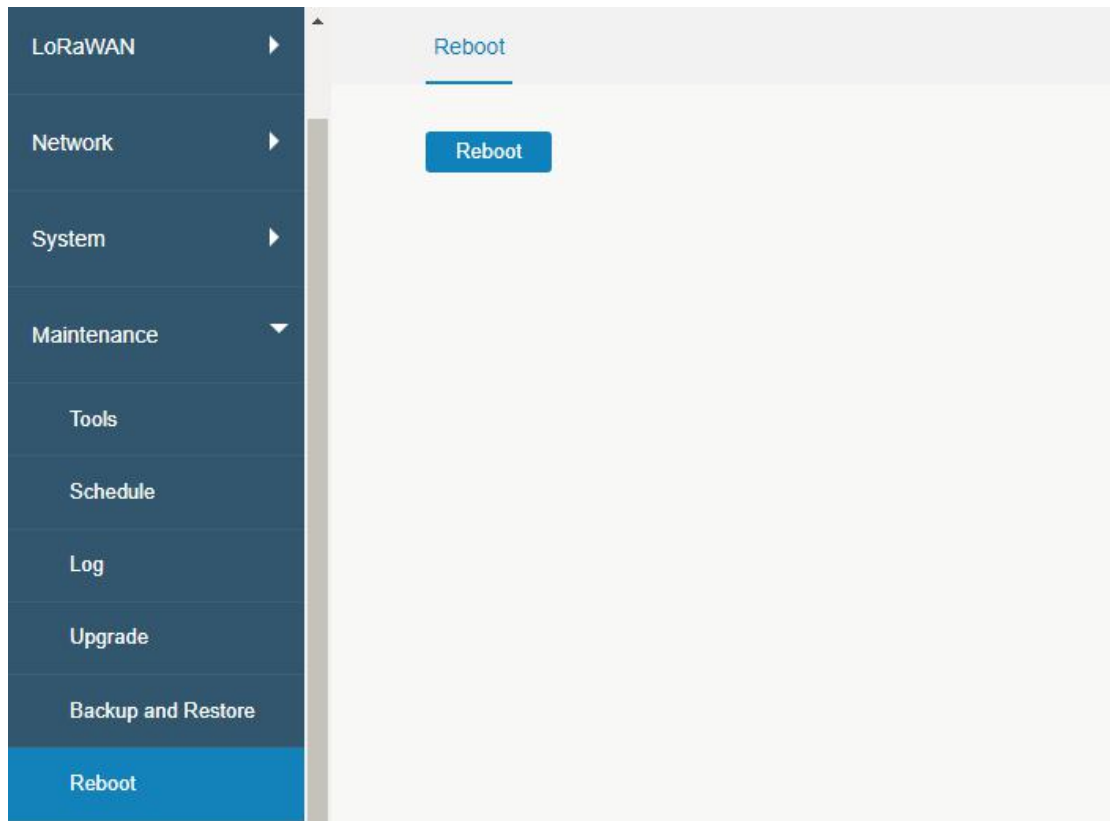

Figure 3-5-6-1

3.6 APP

3.6.1 Python

Python is an object-oriented programming language that has gained popularity because of its clear syntax and readability.

As an interpreted language, Python has a design philosophy that emphasizes code readability, notably using whitespace indentation to delimit code blocks rather than curly brackets or keywords, and a syntax that allows programmers to express concepts in fewer lines of code than it's used in other languages such as C++ or Java. The language provides constructs and intends to enable writing clear programs on both small and large scale.

Users can use Python to quickly generate the prototype of the program, which can be the final interface of the program, rewrite it with a more appropriate language, and then encapsulate the extended class library that Python can call.

This section describes how to view the relevant running status such as App-manager, SDK version, extended storage, etc. Also you can change the App-manager configuration, and import the Python App package from here.

3.6.1.1 Python

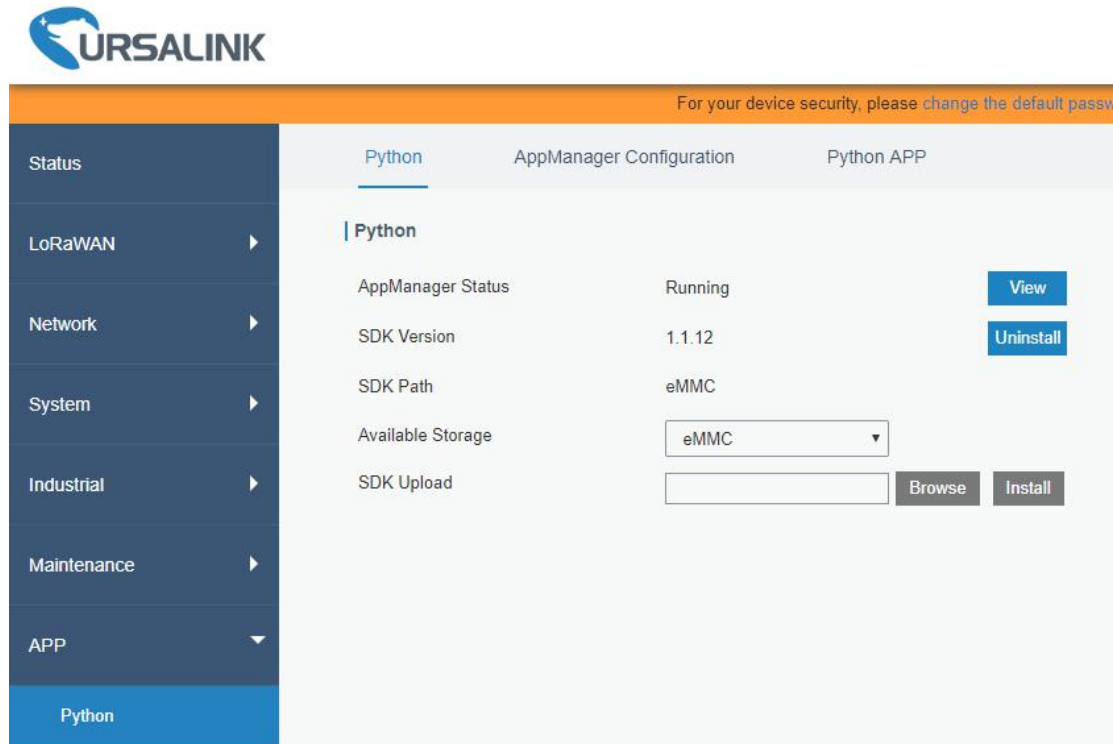

Figure 3-6-1-1

Python	
Item	Description
AppManager Status	Show AppManager's running status, like "Uninstalled", "Running" or "Stopped".
SDK Version	Show the version of the installed SDK.
SDK Path	Show the SDK installation path.
Available Storage	Select available storage to install SDK.
SDK Upload	Upload and install SDK for Python.
Uninstall	Uninstall SDK.
View	View application status managed by AppManager.

Table 3-6-1-1 Python Parameters

3.6.1.2 App Manager Configuration

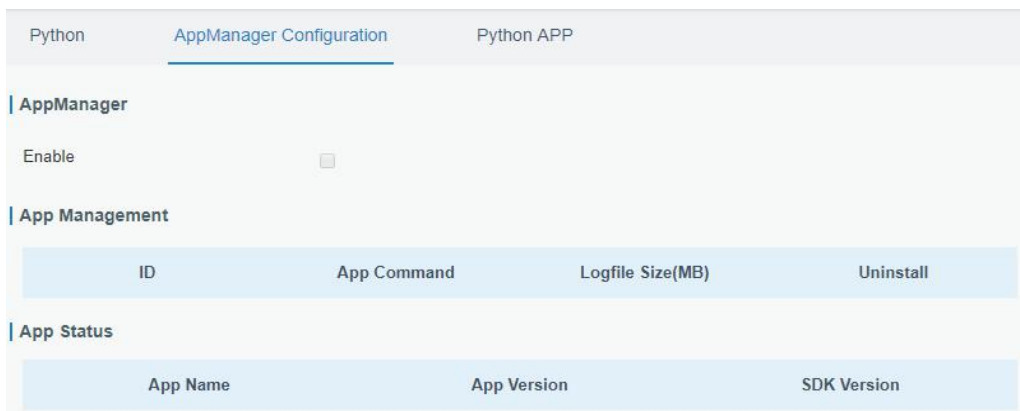

Figure 3-6-1-2

AppManager Configuration	
Item	Description
Enable	After enabling Python AppManager, user can click "View" button on the "Python" webpage to view the application status managed by AppManager.
App Management	
ID	Show the ID of the imported App.
App Command	Show the name of the imported App.
Logfile Size(MB)	User-defined Logfile size. Range: 1-50.
Uninstall	Uninstall APP.
App Status	
App Name	Show the name of the imported App.
App Version	Show the version of the imported App.
SDK Version	Show the SDK version which the imported App is based on.

Table 3-6-1-2 APP Manager Parameters

3.6.1.3 Python App

Figure 3-6-1-3

Python APP	
Item	Description
App Package	Select App package and import.
App Name	Select App to import configuration.
App Configuration	Select configuration file and import.
Debug File	Export script file.
Debug Script	Select Python script to be debugged and import.

Table 3-6-1-3 APP Parameters

Chapter 4 Application Examples

4.1 Application Configuration

You can create a new application on this page, mainly used for defining the method of decoding the data sent from end-device and choose the data transport protocol to send data to another server address. The data will be sent to your custom server address using the MQTT, HTTP or HTTPS protocol.

The configuration procedures are listed as below.

1. Go to “LoRaWAN” > “Network Server” > “Application”.

2. Click  to enter the configuration page, displayed as the following picture:

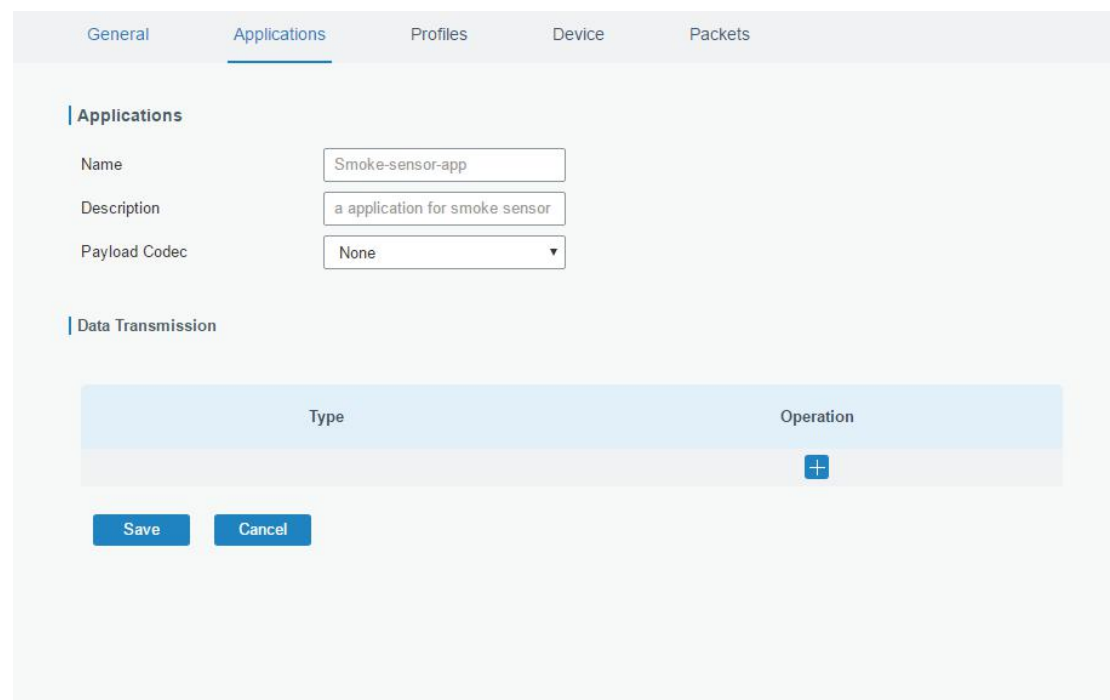

Application Configuration

Item	Description	Default
Name	Enter the name of the application profile. E.g Smoker-sensor-app.	
Description	Enter the description of this application. E.g a application for smoker sensor.	
Payload Codec	Select from: “None”, “Cayenne LPP”, “Custom”. None: This mode enables devices not to encode data. Cayenne LPP: This mode enables devices to encode data with the Cayenne Low Power Payload (LPP). Custom: This mode enables devices to encode data with the decoder function and the encoder function which you have entered the code.	None

- Click  to add a data transmission type of HTTP or HTTPS:

Step 1: select HTTP or HTTPS as transmission protocol.

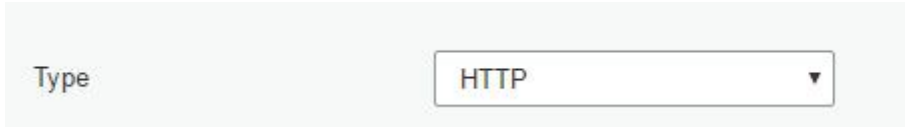

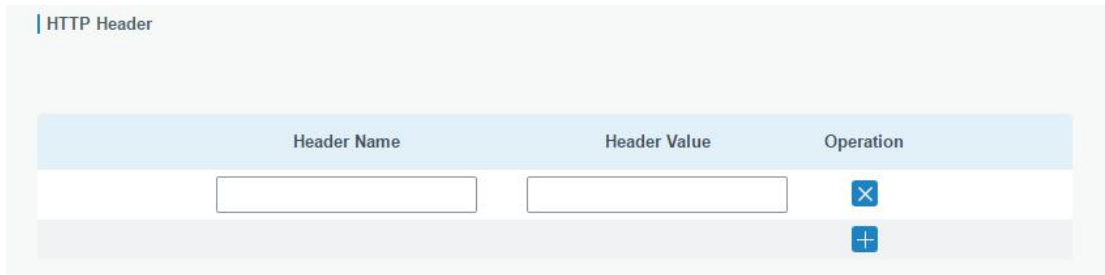

A screenshot of a form element labeled 'Type'. It features a dropdown menu with 'HTTP' selected and a downward-pointing arrow on the right side.

Step 2: Enter the header name and header value as needed.



A screenshot of a table titled 'HTTP Header'. The table has three columns: 'Header Name', 'Header Value', and 'Operation'. The first row contains empty input fields for the first two columns and a blue 'x' icon in the 'Operation' column. A second row contains a blue '+' icon in the 'Operation' column.

Header Name	Header Value	Operation
<input type="text"/>	<input type="text"/>	
		

Headers are name/value pairs that appear in both request and response messages. The name of the header is separated from the value by a single colon.

For example, this request message provides a header called User-Agent whose value is Mozilla/5.0 (Windows NT 6.3; WOW64; Trident/7.0; rv:11.0) like Gecko. The purpose of this particular header is to supply the web server with information about the type of browser making the request.

```
User-Agent: Mozilla/5.0 (Windows NT 6.3; WOW64; Trident/7.0; rv:11.0) like Gecko
```

Step 3: Enter the destination URL. Different types of data can be sent to different URLs.

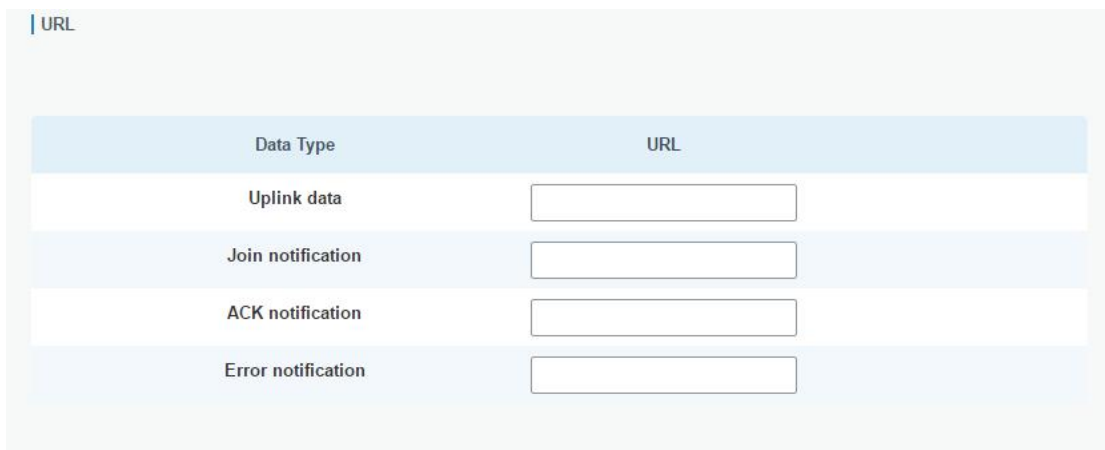

A screenshot of a table titled 'URL'. The table has two columns: 'Data Type' and 'URL'. There are four rows, each with a 'Data Type' and an empty 'URL' input field.

Data Type	URL
Uplink data	<input type="text"/>
Join notification	<input type="text"/>
ACK notification	<input type="text"/>
Error notification	<input type="text"/>

4. Click  to add a data transmission type of MQTT:

Step 1: select the transmission protocol as MQTT.

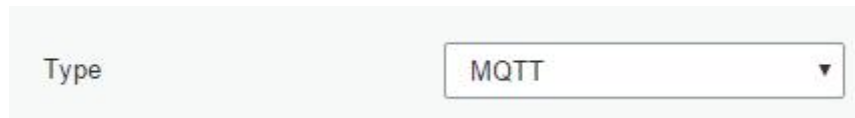

The screenshot shows a configuration panel with a 'Type' label and a dropdown menu. The dropdown menu is currently set to 'MQTT'.

Step 2: Fill in general settings.

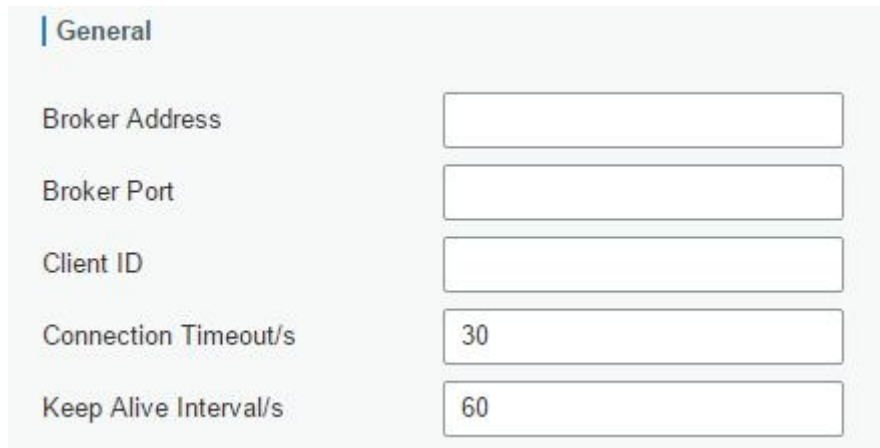

The screenshot shows the 'General' settings section of the MQTT configuration. It includes the following fields:

- Broker Address:
- Broker Port:
- Client ID:
- Connection Timeout/s:
- Keep Alive Interval/s:

MQTT General Settings		
Item	Description	Default
Broker Address	Please enter the broker address to receive data.	--
Broker Port	Please enter the broker port to receive data.	--
Client ID	Client ID is the unique identity of the client to the server. It must be unique when all clients are connected to the same server, and it is the key to handle message at QoS 1 and 2.	--
Connection Timeout	Set the maximum response time when the client waits for the response from the server. If the client does not get a response after the maximum response time, the connection will be considered as broken. The interval range is 1-65535 in second.	30
Keep Alive Interval	After the client is connected with the server, the client will send heartbeat packet to the server regularly to keep alive. The interval range is 1-65535 in second.	60

Step 3: Select the authentication method required by the server.

If you select user credentials for authentication, you need to enter the username and password for authentication.

User Credentials

Enable

Username

Password

If certificate is necessary for verification, please import CA certificate, client certificate and client key file for authentication.

TLS

Enable

CA

Client Certificate

Client Key

Step 4: Enter the topic to receive data and choose the QoS.

QoS 0 – Only Once

This is the fastest method and requires only 1 message. It is also the most unreliable transfer mode.

QoS 1 – At Least Once

This level guarantees that the message will be delivered at least once, but may be delivered more than once.

QoS 2 – Exactly Once

QoS 2 is the highest level of service in MQTT. This level guarantees that each message is received only once by the intended recipients. QoS 2 is the safest and slowest quality of service level.

Topic

Data Type	topic	
Uplink data	<input type="text"/>	QoS 0 ▼
Join notification	<input type="text"/>	QoS 0 ▼
ACK notification	<input type="text"/>	QoS 0 ▼
Error notification	<input type="text"/>	QoS 0 ▼

4.2 Device Profiles Configuration

Device Profiles

Name

Max TXPower

Join Type

Class Type

Advanced

MAC Version

Regional Parameters Revision

ACK Timeout sec

Device Profiles Settings		
Item	Description	Default
Name	Enter the Name of the application profile. E.g. Smoker-sensor-app.	Null
Max TXPower	Enter the maximum transmit power. 0 means using the max EIRP.	0. The TXPower indicates power levels relative to the Max EIRP level of the end-device. 0 means using the max EIRP. EIRP refers to the Equivalent Isotropically Radiated Power.
Join Type	Select from: "OTAA" and "ABP". OTAA:Over-the-Air Activation. For over-the-air activation, end-devices must follow a join procedure prior to participating in data exchanges with the network server. An end-device has to go through a new join procedure every time as it has lost the session context information. ABP: Activation by Personalization. Under certain circumstances, end-devices can be activated by personalization. Activation by personalization directly ties an end-device to a specific network bypassing the join request - join	OTAA

	accept procedure.	
Class Type	<p>Select from: "Class A" and "Class C".</p> <p>A: Class A operation has the lowest power consumption for applications that require downlink communication from the server shortly after the end-device has sent an uplink transmission.</p> <p>C: End-device of Class C will continuously open receive windows, only closed when transmitting. Class C end-device will spend more power than Class A or Class B but they offer the lowest latency for server to end-device communication.</p>	A

Advanced

MAC Version

Regional Parameters Revision

RX1 Datarate Offset

RX2 Datarate

RX2 Channel Frequency HZ

Frequency List Hz

ACK Timeout sec

Device Profile Advanced Settings		
Item	Description	Default
MAC Version	Choose the version of the LoRaWAN supported by the end-device.	1.0.2
Regional Parameter Revision	Revision of the Regional Parameters document supported by the end-device.	B
RX1 Datarate Offset	Enter the offset which used for calculate the RX1 data-rate, based on the uplink data-rate. The range is based on what is specified in the LoRaWAN regional parameters document.	The default offset is based on what is specified in the LoRaWAN regional parameters document.
RX2 Datarate	Enter the RX2 datarate which used for the RX2 receive-window. The range is based on what is specified in the LoRaWAN regional parameters document.	The default offset is based on what is specified in the LoRaWAN regional parameters

		document.
RX2 Channel Frequency	Enter the RX2 channel frequency which used for the RX2 receive-window. The range is based on what is specified in the LoRaWAN regional parameters document.	Null
Frequency List	List of factory-preset frequencies. The range is based on what is specified in the LoRaWAN regional parameters document.	Null
ACK Timeout	Enter the time for confirmed downlink transmissions. Only applicable to class C.	5

4.3 Device Configuration

Go to “LoRaWAN” > “Network Server” > “Device”.

You can edit the device configuration by clicking  or create a new device by clicking .

Device

General

Device Name

Description

Device EUI

Device-Profile

Application

Frame-counter Validation

Device Configuration-General		
Item	Description	Default
Device	Enter the name of this device.	Null
Description	Enter the description of this device.	Null
Device EUI	Enter the EUI of this device.	Null
Device-Profile	Choose the device profile from created device profiles.	Null
Application	Choose the application profile from created application.	Null
Frame-Counter Validation	If disable the frame-counter validation, it will compromise security as it enables people to perform replay-attacks.	Enabled

Activate Device(ABP)	
Device Address	<input type="text" value="068c1b56"/>
Network Session Key	<input type="text" value="17ad9c3acad1df8359b1a68893"/>
Application Session Key	<input type="text" value="9555caa83ec8bb82b2a162452"/>
Uplink Frame-counter	<input type="text" value="1"/>
Downlink Frame-counter	<input type="text" value="1"/>

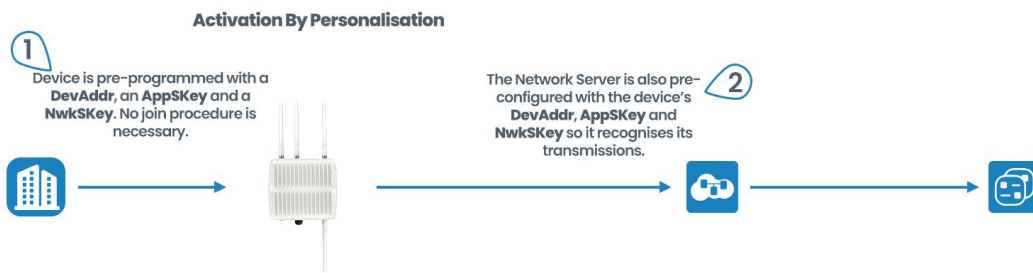

ABP stands for Authentication By Personalisation. It means that the encryption keys are configured manually on the device and can start sending frames to the Gateway without needing a 'handshake' procedure to exchange the keys (such as the one performed during an OTAA join procedure).

With ABP the encryption keys enabling communication with the network are preconfigured in the device. The network will need to provide you with a Device Address, Network Session Key and Application Session Key.

Device Configuration-Activate Device-ABP		
Item	Description	Default
Device Address	Enter the device address. The device address identifies the end-device within the current network.	Null
Network Session Key	Enter the network session key of the device. The network session key specific for the end-device. It is used by the end-device to calculate the MIC or part of the MIC (message integrity code) of all uplink data messages to ensure data integrity.	Null
Application Session Key	Enter the application session key of the device. The AppSKey is an application session key specific for the end-device. It is used by both the application server and the end-device to encrypt and decrypt the payload field of application-specific data messages.	Null
Uplink Frame-counter	The number of data frames which sent uplink to the network server. It will be incremented	Null

	<p>by the end-device and received by the end-device.</p> <p>Users can reset the a personalized end-device manually, then the frame counters on the end-device and the frame counters on the network server for that end-device will be reset to 0.</p>	
Downlink Frame-counter	<p>The number of data frames which received by the end-device downlink from the network server. It will be incremented by the network server.</p> <p>Users cloud reset the a personalized end-device manually, then the frame counters on the end-device and the frame counters on the network server for that end-device will be reset to 0.</p>	Null

Activate Device(OTAA)

Application Key

Device Address

Network Session Key

Application Session Key

Uplink Frame-counter

Downlink Frame-counter

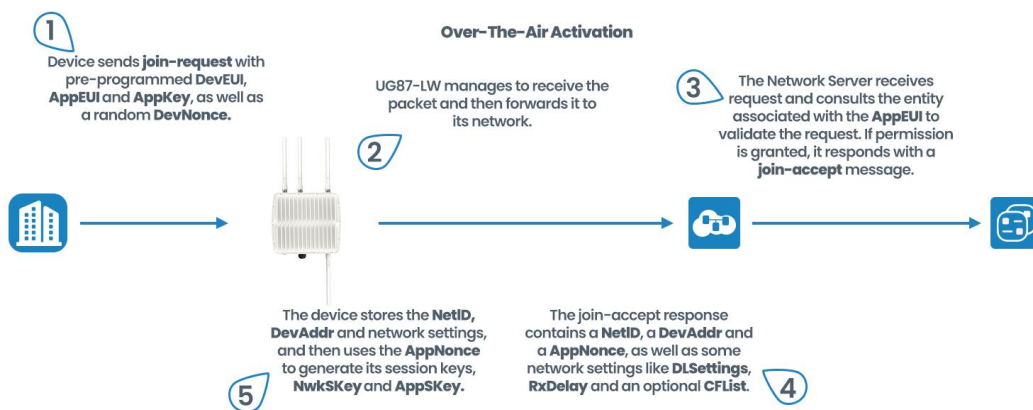

OTAA stands for Over The Air Activation. With this method the end-device sends a Join request to the gateway using the Application Key, Application Key is a shared secret key unique to your device to generate the session keys that prove its identity to the network. If the keys are correct, the gateway will reply to the end-device with a join accept message, and from that point on the end-device is able to send and receive packets to/from gateway. If the keys are incorrect, no response will be received.

Device Configuration-Activate Device-OTAA		
Item	Description	Default
Application Key	Enter the application key. Whenever an end-device joins a network via over-the-air activation, the application key is used for derive the Application Session key.	Null
Device Address	Show the device address when the device has been activated. The device address identifies the end-device within the current network.It will be cleared when the node has not been activated yet or device has been inactive for a long time.	Null
Network Session Key	Show the network session key of the device when the device has been activated. The network session key specific for the end-device. It is used by the end-device to calculate the MIC or part of the MIC (message integrity code) of all uplink data messages to ensure data integrity.It will be cleared when the node has not been activated yet or device has been inactive for a long time.	Null
Application Session Key	Show the application session key of the device when the device has been activated. The AppSKey is an application session key specific for the end-device. It is used by both the application server and the end-device to encrypt and decrypt the payload field of application-specific data messages. It will be cleared when the node has not been activated yet or device has been inactive for a long time.	Null
Uplink Frame-counter	The number of data frames which sent uplink to the network server. It will be incremented and received by the end-device. After a JoinReq -JoinAccept message exchange, the frame counters on the end-device and the frame counters on the network server for that end-device will be reset to 0.	Null
Downlink Frame-counter	The number of data frames which received by the end-device downlink from the network server. It will be incremented by the network server. After a JoinReq -JoinAccept message exchange, the frame counters on the end-device and the frame counters on the network server for that end-device will be reset to 0.	Null

4.4 Send Data to Device

Go to “LoRaWAN” > “Network Server” > “Packets”.

Step 1: Please check the packet in the network server list to make sure that the device has joined the network successful.

1122612191	868100000	SF7BW125	-	-	17	0	JnAcc	2019-08-06T09:22:29+08:00	!
112261219	868100000	SF7BW125	9.5	-77	18	0	JnReq	2019-08-06T09:22:29+08:00	!

Step 2: Fill these input box.

Send Data To Device

Device EUI	Type	Payload	Fport	Confirmed
<input type="text" value="11226121913"/>	ASCII	<input type="text" value="15"/>	<input type="text" value="15"/>	<input checked="" type="checkbox"/>

Step 3: Click "Send".



Step 4: Check the packet in the network server list to make sure that the device has received this message successful.

Note: please enable the "confirmed".

Send Data To Device

Device EUI	Type	Payload	Fport	Confirmed
<input type="text" value="11226121913"/>	ASCII	<input type="text" value="15"/>	<input type="text" value="15"/>	<input checked="" type="checkbox"/>

You can click "Refresh" to refresh the list or set automatic refreshing frequency for the list.

If the device's class type is Class C, then the device will be constantly receiving packet.

This packet's type is DnCnf (Downlink Confirmed Packet) and if the packet's color is gray, then it means the packet cannot be transmitted now because at least one message has been in the queue.

1122612191?	0	6	2	DnCnf	!
-------------	---	---	---	-------	---

This is the data packet has been delivered successfully.

1122612191311123	869525000	SF12BW125	-	-	6	2	DnCnf	2019-08-06T09:22:55+08:00	Success !
1122612191311123	0	-	-	6	2	DnCnf		Pending !	

If the device receives this downlink confirmed packet, then the device will reply "ACK" when delivering next.

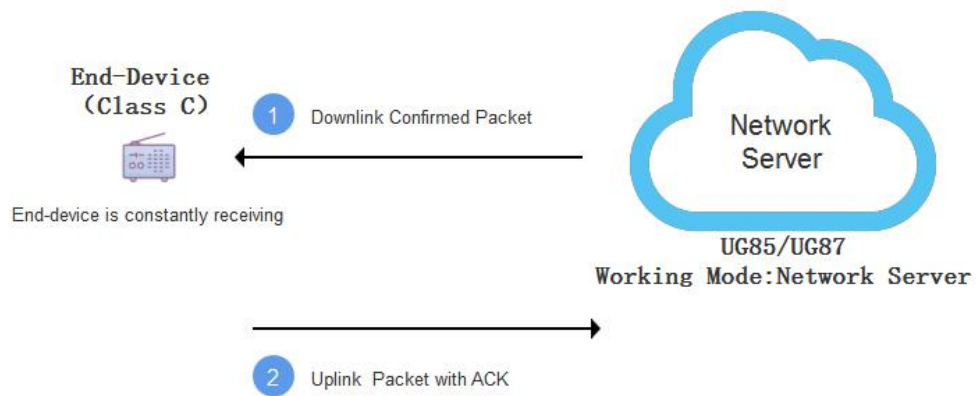

Device EUI	Frequency	Datarate	SNR	RSSI	Size	Fcnt	Type	Time	Details
11226121913	868300000	SF10BW125	-	-	0	3	DnUnc	2019-08-06T09:23:44+08:00	!
1122612191	868300000	SF10BW125	10.5	-75	64	2	UpCnf	2019-08-06T09:23:44+08:00	!
1122612191	869525000	SF12BW125	-	-	6	2	DnCnf	2019-08-06T09:22:55+08:00	!
1122612191	0				6	2	DnCnf		!
1122612191	868500000	SF10BW125	-	-	0	1	DnUnc	2019-08-06T09:22:49+08:00	!

Packets Details

Dev Addr	07e7
GwEUI	24e124ff
AppEUI	557240
DevEUI	1122612191311123
Immediately	-
Timestamp	874346044
Type	UpCnf
Adr	false
AdrAckReq	false
Ack	true
Fcnt	21
Fport	55
Modulation	LORA

Ack is "true" means that the device has received this packet.

If the device's class type is Class A, then the Network Server communicates with end-device (downlink) during predetermined response windows.

This packet's type is DnCnf (Downlink Confirmed Packet) and if the packet's color is gray, then it means that the packet cannot be transmitted now because at least one message has been in queue.

112261219172	0	6	2	DnCnf	!
--------------	---	---	---	-------	---

Only after the device sends out an uplink packet will the network server sends out data to the device.

Device EUI	Frequency	Datarate	SNR	RSSI	Size	Fcnt	Type	Time	Details
1122612191311123	868300000	SF10BW125	-	-	0	19	DnUnc	2019-08-06T09:49:38+08:00	!
1122612191311123	868300000	SF10BW125	10.8	-76	64	21	ACK	2019-08-06T09:49:38+08:00	!
1122612191311123	868300000	SF10BW125	10.8	-76	64	21	UpCnf	2019-08-06T09:49:38+08:00	!
1122612191311123	868100000	SF10BW125	-	-	6	18	DnCnf	2019-08-06T09:48:43+08:00	Success
1122612191311123	868100000	SF10BW125	9.8	-77	64	20	UpCnf	2019-08-06T09:48:43+08:00	!
1122612191311123	0				6	18	DnCnf	Pending	!
1122612191311123	868500000	SF10BW125	-	-	0	17	DnUnc	2019-08-06T09:47:38+08:00	!
1122612191311123	868500000	SF10BW125	8.0	-76	64	19	UpCnf	2019-08-06T09:47:38+08:00	!
1122612191311123	868100000	SF10BW125	-	-	0	16	DnUnc	2019-08-06T09:46:38+08:00	!
1122612191311123	868100000	SF10BW125	11.2	-74	64	18	UpCnf	2019-08-06T09:46:37+08:00	!

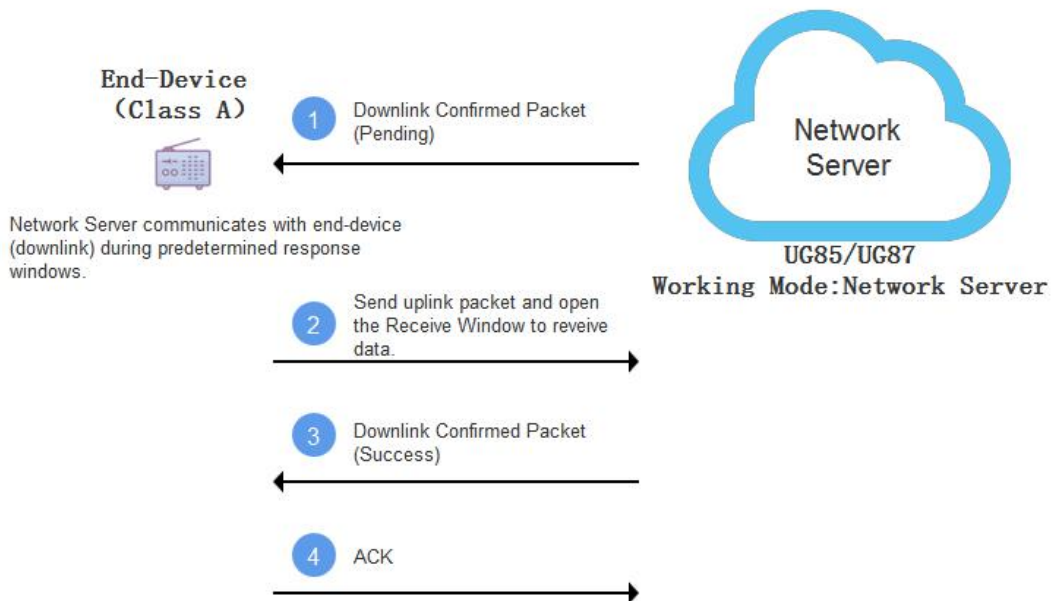

Network Server

Clear Search

Device EUI	Frequency	Datarate	SNR	RSSI	Size	Fcnt	Type	Time	Details
1122612191311123	868300000	SF10BW125	-	-	0	19	DnUnc	2019-08-06T09:49:38+08:00	!
1122612191311123	868300000	SF10BW125	10.8	-76	64	21	ACK	2019-08-06T09:49:38+08:00	!
1122612191311123	868300000	SF10BW125	10.8	-76	64	20	UpCnf	2019-08-06T09:49:38+08:00	!
1122612191311123	868100000	SF10BW125	-	-	6	18	DnCnf	2019-08-06T09:48:43+08:00	!
1122612191311123	868100000	SF10BW125	9.8	-77	64	20	UpCnf	2019-08-06T09:48:43+08:00	!
1122612191311123	0				6	18	DnCnf		!
1122612191311123	868500000	SF10BW125	-	-	0	17	DnUnc	2019-08-06T09:47:38+08:00	!
1122612191311123	868500000	SF10BW125	8.0	-76	64	19	UpCnf	2019-08-06T09:47:38+08:00	!
1122612191311123	868100000	SF10BW125	-	-	0	16	DnUnc	2019-08-06T09:46:38+08:00	!
1122612191311123	868100000	SF10BW125	11.2	-74	64	18	UpCnf	2019-08-06T09:46:37+08:00	!

Showing 51 to 60 of 355 rows rows per page Manual Refresh

means the device has received the packet you send.

Related Topic

[Packets](#)

4.5 Restore Factory Defaults

4.5.1 Via Web Interface

1. Log in web interface, and go to “Maintenance > Backup and Restore”.
2. Click “Reset” button under the “Restore Factory Defaults”.

You will be asked to confirm if you’d like to reset it to factory defaults. Then click “Reset” button.

Backup and Restore

Restore Config

Config File

Backup Running-config

Restore Factory Defaults

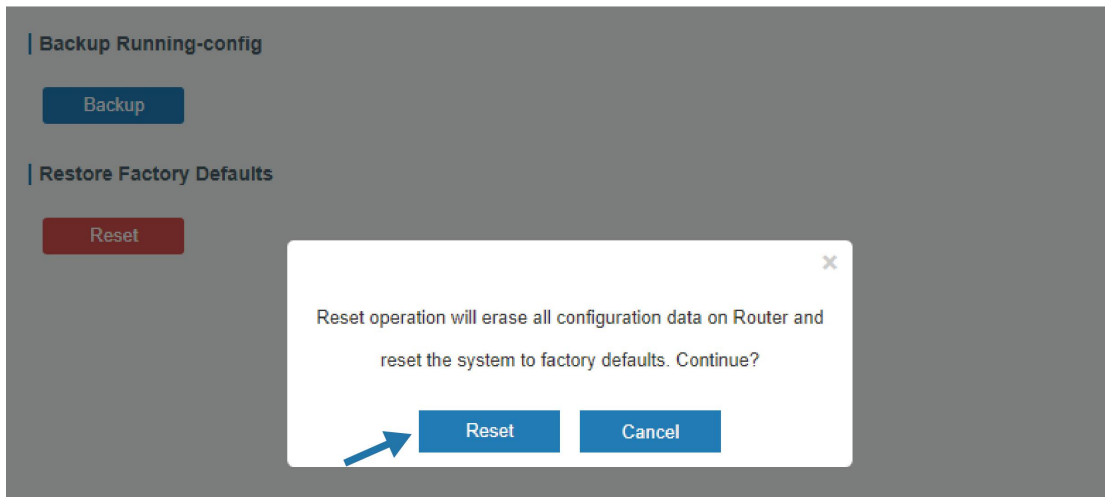

Then the gateway will reboot and restore to factory settings immediately.

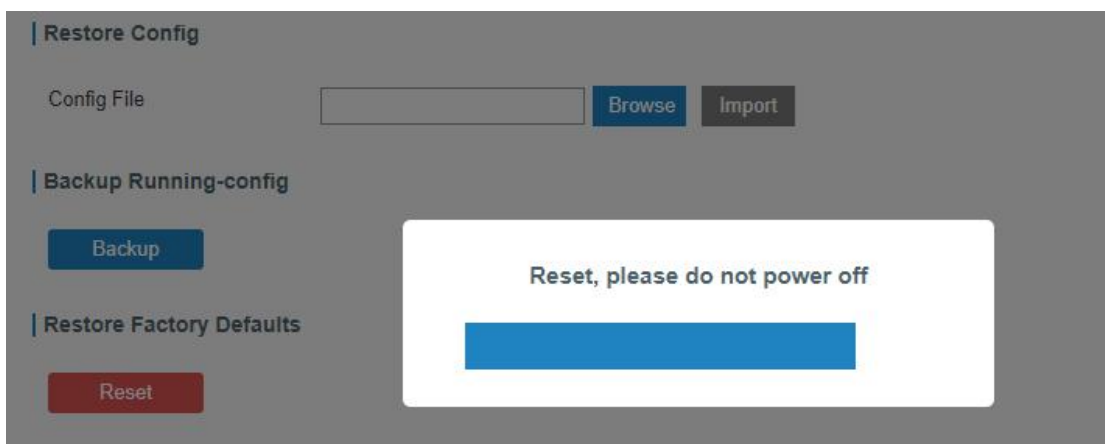

Please wait till the login page pops up again, which means the gateway has already been reset to factory defaults successfully.

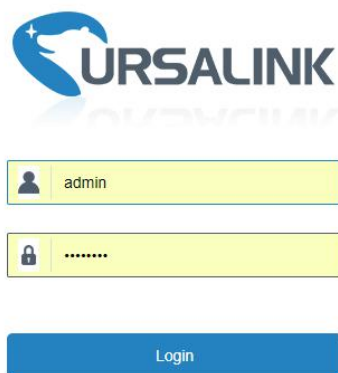

Related Topic

[Restore Factory Defaults](#)

4.5.2 Via Hardware

Locate the reset button on the gateway, and take corresponding actions based on the status of SYS LED.

SYSTEM LED	Action
Blinking	Press and hold the reset button for more than 15 seconds.
Static Green → Rapidly Blinking	Release the button and wait.
Off → Blinking	The gateway is now reset to factory defaults.

4.6 Firmware Upgrade

It is suggested that you contact Ursalink technical support first before you upgrade gateway firmware.

After getting firmware file from Ursalink technical support, please refer to the following steps to complete the upgrade.

1. Go to “Maintenance > Upgrade”.
2. Click “Browse” and select the correct firmware file from the PC.
3. Click “Upgrade” and the gateway will check if the firmware file is correct. If it’s correct, the firmware will be imported to the gateway, and then the gateway will start to upgrade.

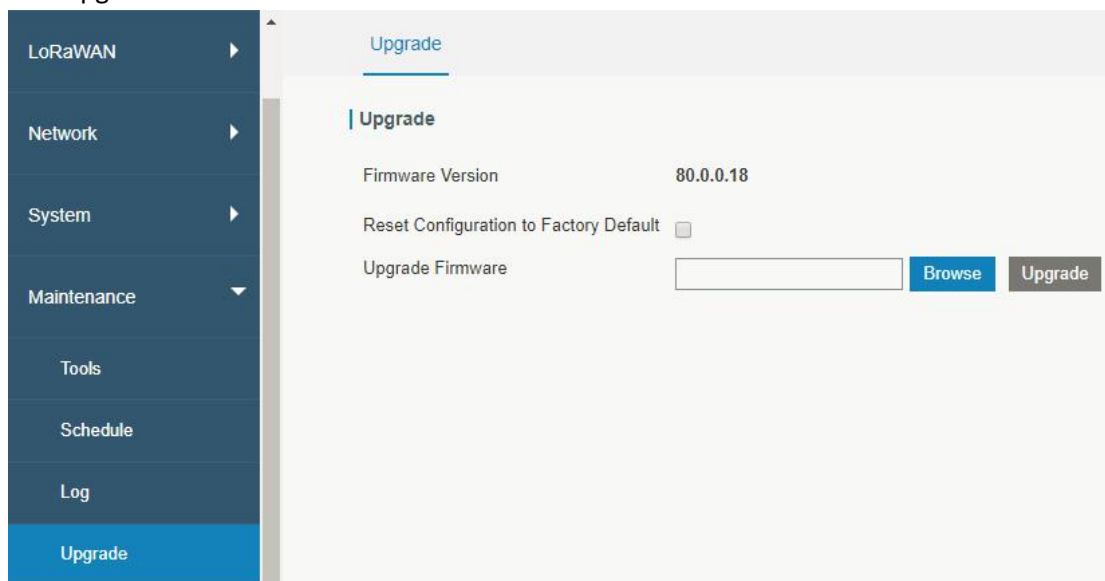

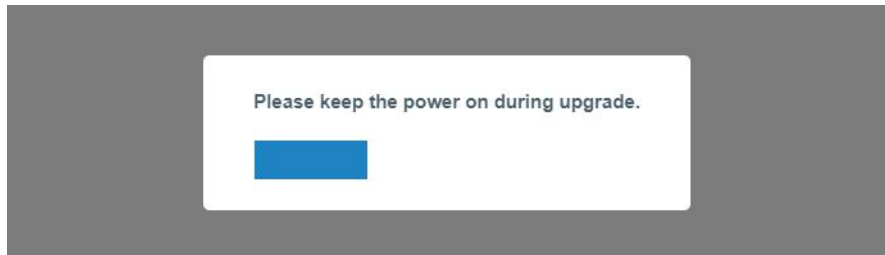
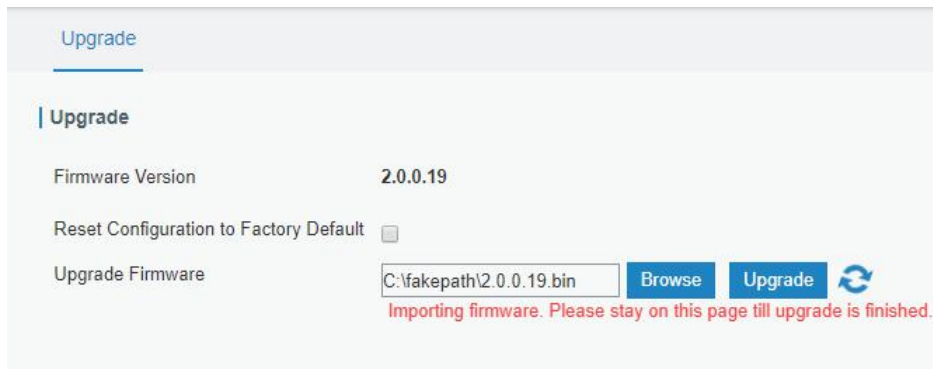

Related Topic

[Upgrade](#)

4.7 Cellular Connection

The UG87 have two cellular interfaces, named SIM1 & SIM2. Only one cellular interface is active at one time. If both cellular interfaces are enabled, SIM1 interface takes precedence as default.

Example

We are about to take an example of inserting a SIM card into SIM1 slot of the UG87 and configuring the gateway to get Internet access through cellular.

Configuration Steps

1. Go to "Network > Interface > Cellular > Cellular Setting" and configure the cellular info.
2. Enable SIM1.
3. Choose relevant network type. "Auto", "4G First", "4G Only", "3G First", "3G Only", "2G First" and "2G only" are optional.

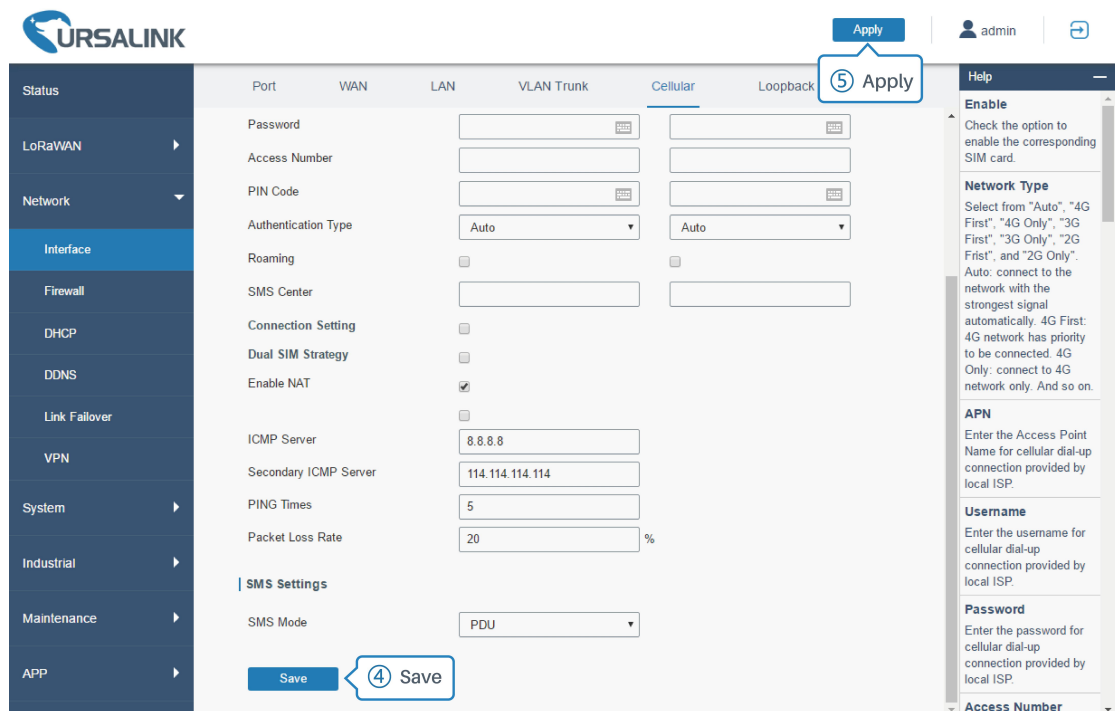
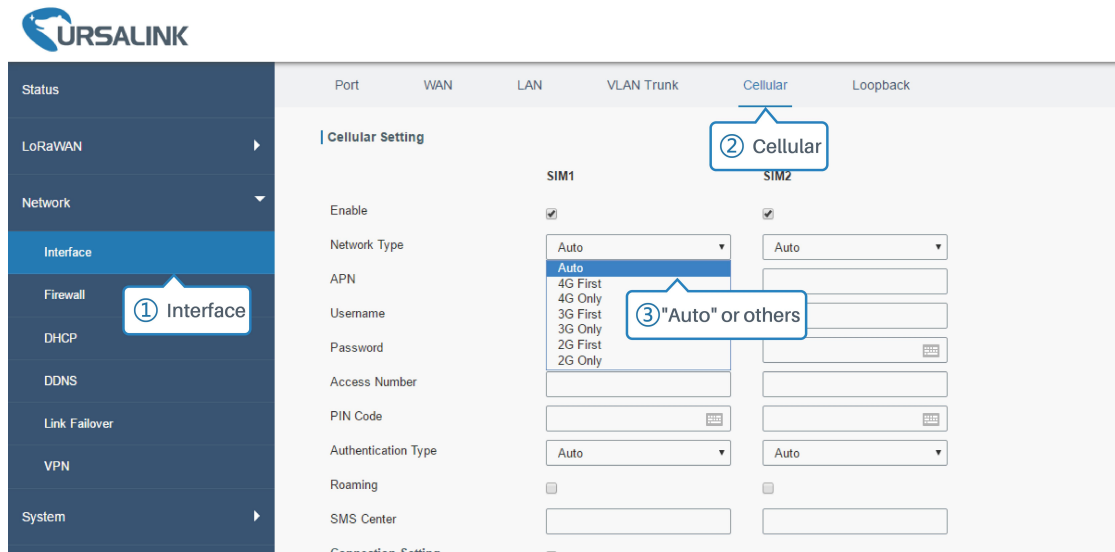

Click “Save” and “Apply” for configuration to take effect.

Note:

If you select “Auto”, the gateway will obtain ISP information from SIM card to set APN, Username, and Password automatically. This option will only be taken effect when the SIM card is issued from well-known ISP.

If you select “4G First” or “4G Only”, you can click “Save” to finish the configuration directly.

If you select “3G First”, “3G Only”, “2G First” or “2G Only”, you should manually configure APN, Username, Password, and Access Number.

4. Check the cellular connection status by WEB GUI of gateway.

Click “Status > Cellular” to view the status of the cellular connection. If it shows 'Connected', SIM1 has dialed up successfully.

Overview	Cellular	Network	WLAN	VPN	Routing	Host List	GPS
Modem							
Status	Ready						
Model	U9300C						
Current SIM	SIM1						
Signal Level	29asu (-56dBm)						
Register Status	Registered (Home network)						
IMSI	460070615219248						
ICCID	898602E6131532019248						
ISP	CHINA MOBILE						
Network Type	LTE						
PLMN ID	46007						
LAC	fffe						
Cell ID	f700e28						
IMEI	862808032459987						
Network							
Status	Connected						
IP Address	10.39.128.14						
Netmask	255.255.255.252						
Gateway	10.39.128.13						
DNS	211.143.147.120						
Connection Duration	0 days, 00:15:35						
							Manual Refresh
							Refresh

5. Check out if network works properly by browser on PC.

Open your preferred browser on PC, type any available web address into address bar and see if it is able to visit Internet via the UG87.

Related Topic

[Cellular Setting](#)

[Cellular Status](#)

4.8 Dual SIM Backup Application Example

Example

In this section we will take an example of inserting two SIM cards into the UG87. When one SIM fails, gateway will try to connect with the other SIM as backup link.

Configuration Steps

1. Go to "Network > Interface > Cellular" to enable SIM1 and SIM2. Leave the network type as "Auto" by default.

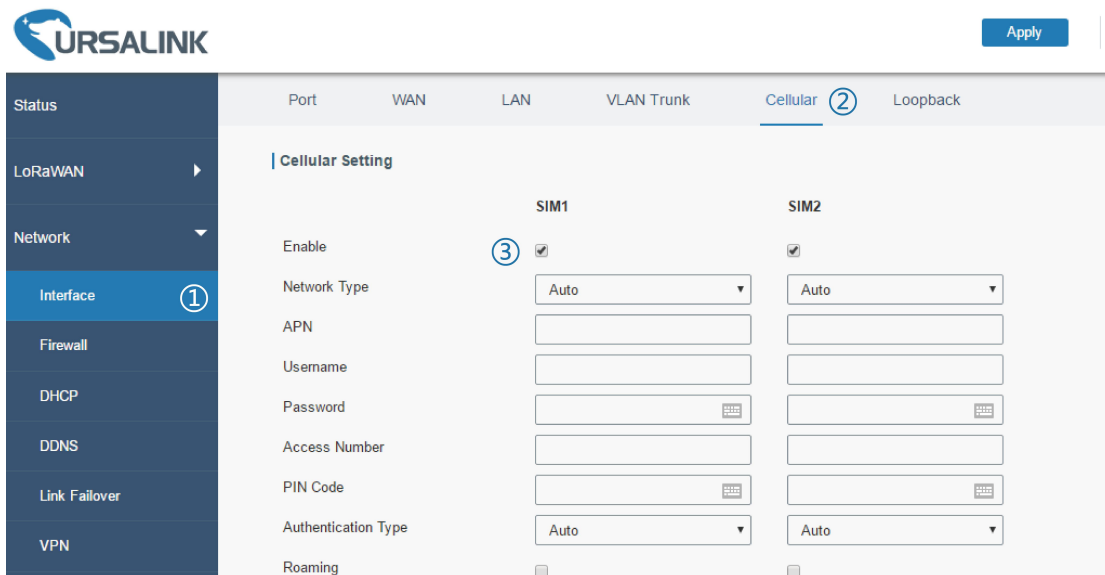

2. Enable “Dual SIM Strategy”, and configure the corresponding options as below. ICMP server can be configured as any reachable IP address.

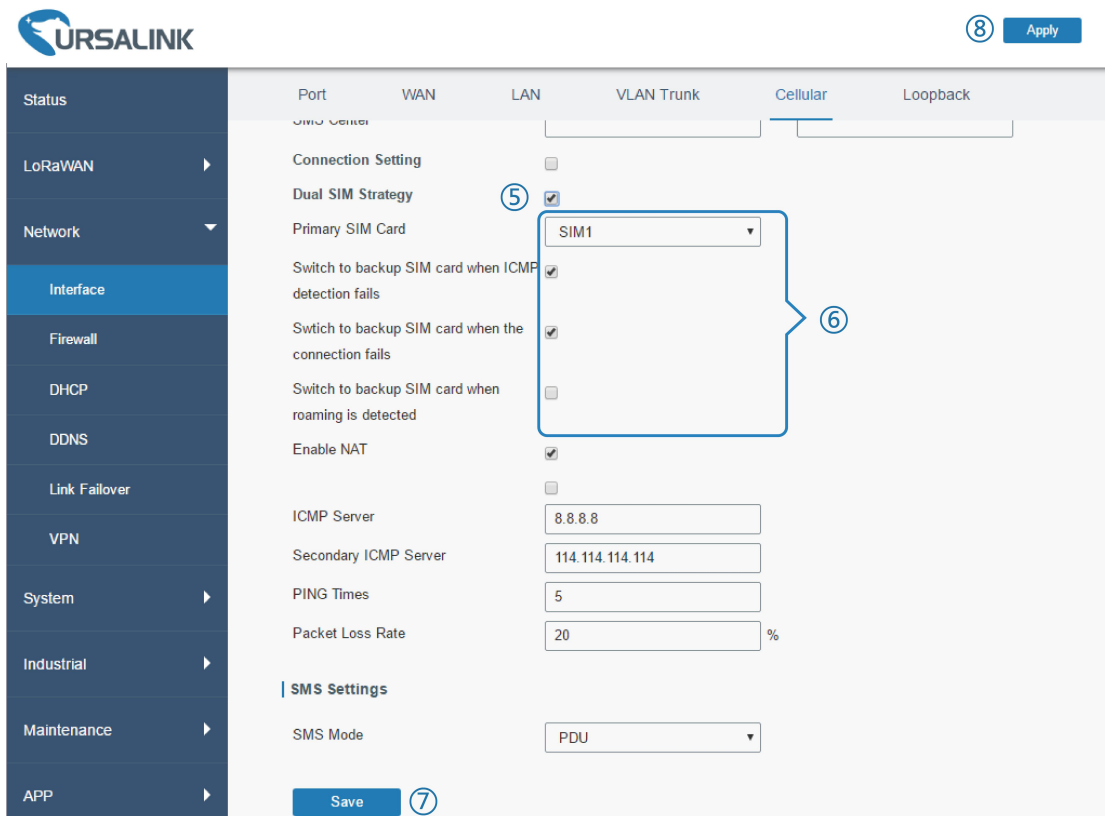

Then click “Save” and “Apply” button.

3. Go to “Status > Cellular”, and you will see the gateway is connected to the network via SIM1.

Overview	Cellular	Network	VPN	Routing
Modem				
Status	Ready			
Model	EC25			
Current SIM	SIM1			
Signal Level	15asu (-83dBm)			
Register Status	Registered (Home network)			
IMSI	460019987103071			
ICCID	89860117838019196629			
ISP	CHN-UNICOM			
Network Type	LTE			

Network	
Status	Connected
IP Address	10.105.39.33

- You can remove SIM1 to make the gateway fail to connect to network via it. Go to “Status > Cellular” again, and you will see the gateway is connected to the network through SIM2.

Overview	Cellular	Network	VPN	Routing
Modem				
Status	Ready			
Model	EC25			
Current SIM	SIM2			
Signal Level	15asu (-83dBm)			
Register Status	Registered (Home network)			
IMSI	460019987103071			
ICCID	89860117838019196629			

Network	
Status	Connected
IP Address	10.63.223.44

Now SIM2 becomes the main SIM, and SIM1 runs as the backup. The gateway won't reconnect via SIM1 until SIM2 fails.

Related Topic[Cellular Setting](#)[Cellular Status](#)**4.9 Wi-Fi Application Example****4.9.1 AP Mode****Application Example**

Configure UG87 as AP to allow connection from users or devices.

Configuration Steps

1. Go to “Network > Interface > WLAN” to configure wireless parameters as below.

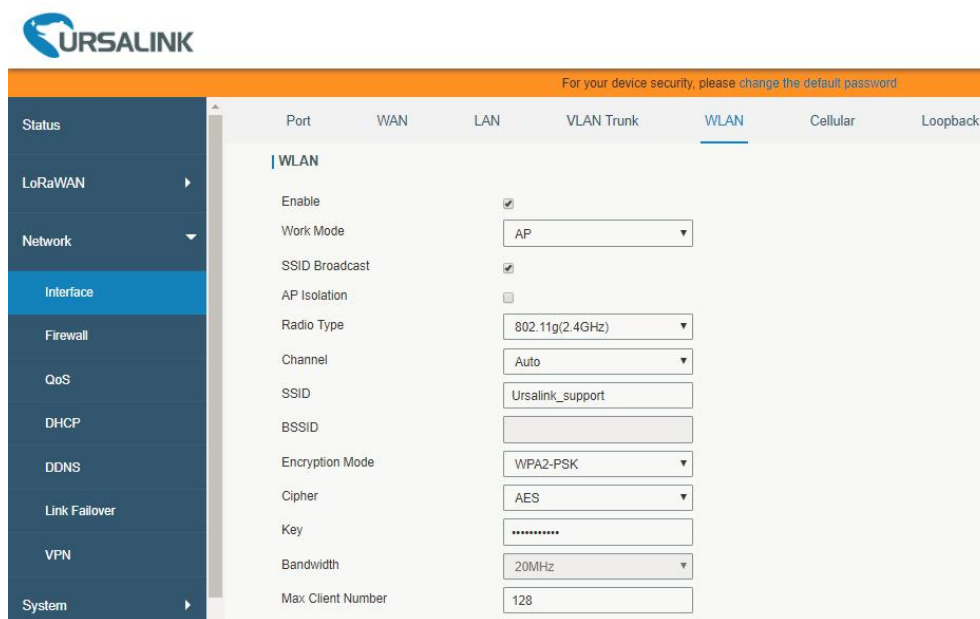

Click “Save” and “Apply” buttons after all configurations are done.

2. Use a smart phone to connect by SSID “Ursalink_F0257A”. Go to “Status > WLAN”, and you can check the AP settings and information of the connected client/user.

Overview	LoRa	Cellular	Network	WLAN	VPN	Host List
WLAN Status						
Wireless Status	Enabled					
MAC Address	24:e1:24:f0:27:85					
Interface Type	AP					
SSID	Ursalink_support					
Channel	Auto					
Encryption Type	WPA2-PSK					
Cipher	AES					
Status	Up					
IP Address	192.168.100.1					
Netmask	255.255.255.0					
Connection Duration	0 days, 03:16:08					

4.9.2 Client Mode

Application Example

Configure UG87 as Wi-Fi client to connect to an access point to have Internet access.

Configuration Steps

1. Go to “Network > Interface > WLAN” to configure wireless as below.

For your device security, please change the default password.

Port WAN LAN VLAN Trunk **WLAN** Cellular Loopback

WLAN

Enable

Work Mode Client

SSID Meeting Room

BSSID 24:e1:24:f0:01:77

Encryption Mode WPA2-PSK

Cipher AES

Key

IP Setting

Protocol DHCP Client

Click “Save” and “Apply” buttons after all configurations are done.

2. Go to “Status > WLAN”, and you can check the connection status of the client.

Overview	LoRa	Cellular	Network	<u>WLAN</u>	VPN	Host List
 WLAN Status						
Wireless Status		Enabled				
MAC Address		24:e1:24:f0:27:85				
Interface Type		Client				
SSID		Meeting Room				
Channel		Auto				
Encryption Type		WPA2-PSK				
Cipher		AES				
Status		Connected				
IP Address		0.0.0.0				
Netmask		0.0.0.0				
Connection Duration		0 days, 00:00:00				

Related Topic[WLAN Setting](#)[WLAN Status](#)**[END]**